

Limited Warranty

To the original purchaser ("OWNER") only, Cochran Undersea Technology, a division of Cochran Consulting, Inc. ("COCHRAN"), represents this Product to be free of defects in both materials and workmanship under normal SCUBA use for 24 months from the date of shipment from COCHRAN to the Authorized Dealer or Distributor. For purposes of establishing warranty eligibility, this date may be noted on the original product box, or can be determined by contacting COCHRAN.

Any defective Product, unless cause is specifically excluded in the "Warranty Conditions and Limitation" section below will at the sole discretion of COCHRAN, be repaired, replaced, or replaced with a new or refurbished unit of comparable or better function and/or condition. COCHRAN is not responsible for any incidental or secondary damages as a result of Product malfunction

WARRANTY LIMITATIONS AND EXCLUSIONS

Product must have been obtained from a COCHRAN Authorized Dealer. Contact COCHRAN for verification of dealer status. This Warranty is not transferable.

The warranty registration card must be sent to COCHRAN within 15 days of the purchase in order to validate Limited Warranty

Failure to provide proper care for this Product will render this Limited Warranty null and void. Damages or malfunction resulting from accidental or deliberate abuse, tampering, battery leakage, exceeding maximum intended operating depth or other parameters, extreme heat or cold, or other conditions that COCHRAN deem to be outside the intended scope of this Limited Warranty are not covered. Plastics, o-rings, batteries, battery life and flooded battery compartments are NOT covered by this Limited Warranty.

OWNER is responsible for shipping this Product to COCHRAN for service, and paying all associated costs, including shipping, insurance, and import duties. OWNER may take Product to an Authorized Dealer to arrange service under terms of this Limited Warranty. COCHRAN will return Product to OWNER or Dealer via a method and carrier of its choosing. Costs for requested expedited return shipping will be the responsibility of OWNER. Product returned for service under terms of this Limited Warranty must be accompanied by a photocopy of the original sales receipt in order for warranty repair or replacement to be performed if the Warranty Registration Card is not on file.

STATEMENT OF LIMITED LIABILITY

A mathematical model is used by this Product to calculate physiological effects of SCUBA diving related to use of compressed air or other breathing mixtures while at depth. Such effects specifically relate to nitrogen absorption into and elimination from body tissues, as well as effects of oxygen used in Enriched Air Nitrox breathing mixtures.

However, because of the number of variables and the varying degrees to which they may affect individuals engaged in SCUBA diving, COCHRAN DOES NOT GUARANTEE THAT USE OF THIS PRODUCT WILL PREVENT DECOMPRESSION SICKNESS OR ANY OTHER CONDITION OR INJURY INCURRED WHILE USING THIS PRODUCT.

These influencing variables may include, but are not limited to, dehydration, obesity, age, old injuries, or other physical conditions on the part of the diver, or environmental extremes of heat or cold, or poor training, or diving practices, any of which may promote the onset of decompression sickness or other harmful effects.

This Product is sold and intended to be used only as a guide, providing the TRAINED and CERTIFIED diver the information needed to make safe diving decisions. It is expressly understood that by buying and/or using this Product the Diver assumes ALL RISK as to its operability, reliability, quality, performance, accuracy, and suitability for his diving style. Furthermore, Diver recognizes that this Product is an electronic instrument being used in a hostile environment and is subject to failure, which may manifest itself in a number of ways. COCHRAN and its distributors and retailers will not be held liable for any personal injuries or other damages resulting from its use, even if COCHRAN has been advised of such occurrences or damages.

These products must be handled with care and properly maintained to assure the optimum performance. Users must possess the proper training for SCUBA diving activities and should be fully educated in the operation of this product. Users are encouraged to possess and utilize a redundant (backup) computer for their dive planning and execution. And divers are always encouraged to dive with a buddy at all times.

COCHRAN strongly supports and agrees with maximum depth limits of 130 feet for recreational SCUBA diving, as established by recognized training and certification agencies, and in no way encourages diving beyond these or any prudent lesser limits as may be necessitated by environmental, diver-specific, or other conditions.

THE WARRANTY AND REMEDIES SET FORTH ABOVE ARE EXCLUSIVE AND IN LIEU OF ALL OTHERS, WHETHER ORAL OR WRITTEN, EXPRESSED OR IMPLIED. COCHRAN UNDERSEA TECHNOLOGY SPECIFICALLY DISCLAIMS ANY AND ALL IMPLIED WARRANTIES, INCLUDING, WITHOUT LIMITATION, WARRANTIES OF MERCHANTABILITY AND FITNESS FOR A PARTICULAR PURPOSE. No Cochran Undersea Technology dealer, agent, or employee is authorized to make any modification, extension, or addition to this warranty.

DO NOT ALLOW THE NEMESIS®+ TO HAVE LOW OR NO BATTERIES FOR ANY EXTENDED PERIOD OF TIME! THIS WILL DISCHARGE THE INTERNAL LITHIUM BATTERY THAT KEEPS THE MEMORY ALIVE!

CAUTION!!! LOSS OF BATTERY POWER WILL CAUSE ALL PREVIOUS DIVE NITROGEN LOADING TO BE LOST. THIS MAY AFFECT NITROGEN CALCULATIONS ON NEAR-FUTURE DIVES. AFTER A BATTERY CHANGE,

CONFIRM THAT NO-DECOMPRESSION TIME DATA IS REASONABLE DURING PRE-DIVE PREDICTION MODE. DIVE-OF-DAY NUMBER GOING TO ZERO IMMEDIATELY AFTER CHANGING BATTERIES IS ANOTHER INDICATION OF A LOSS OF NITROGEN LOADING.

(C) 1998 Cochran Undersea Technology
NEMESIS® + Manual
English - Imperial
Version 001i
FCC Label

FCC ID: LYP744556-01

This device complies with Part 15 of the FCC Rules. Operation is subject to the following two conditions: (1) this device may not cause harmful interference, and (2) this device must accept any interference received, including interference that may cause undesired operation.

Interference Statement

NOTE: This equipment has been tested and found to comply with both the limits for a Class B digital device and an intentional radiator, pursuant to Part 15, Subpart B/C of the FCC Rules. This equipment generates, uses, and radiates radio frequency energy. If not installed and used in accordance with the instructions, it may cause interference to radio communications. The limits are designed to provide reasonable protection against such interference in a residential situation. However, there is no guarantee that interference will not occur in a particular installation. If this equipment does cause interference to radio or television reception, which can be determined by turning the equipment on and off, the user is encouraged to try to correct the interference by one or more of the following measures:

- Reorient or relocate the receiving antenna of the affected radio or television.
- Increase the separation between the equipment and the affected receiver.
- Connect the equipment and the affected receiver to power outlets on separate circuits.
- Consult the dealer or an experienced radio/TV technician for help.

MODIFICATIONS

Changes or modifications not expressly approved by Cochran Consulting, Inc. could void the user's authority to operate the equipment.

SHIELDED CABLES

This product is designed to be used only with the Analyst[®] interface cable (RS-232) to maintain compliance with FCC Regulations.

Patent Information

Protected under one or more Foreign or US patents. Other patents may be pending.

All specifications subject to change without prior notice. Nemesis and Analyst are registered trademarks of Cochran Consulting, Inc. Copyright 1998 Cochran Consulting, Inc.



NORMES EMC 89/336/EEC
EMC 89/336/EEC STANDARDS
HOMOLOGADA EMC 89/336/EEC
ZERTIFIZIERUNG EMC 89/336/EEC

TABLE OF CONTENTS

Limited Warranty and Liability Statement	1
Product Certifications	4
Patent Information	5
Table of Contents	6
Introduction	7
SECTION I. OVERVIEW	9
User & Environmental Adaptation	9
Altitude Acclimatization	9
Water Temperature Compensation	10
Ascent Rate Compensation	10
User Conservatism	10
Previous Dive Profile	11
Salt/Fresh Water Compensation	11
Workload Compensation	11
Nitrox-specific Functions	12
Equivalent Air Depth	12
CNS and OTU Oxygen Toxicity	12
SECTION II. Installation	14
Activation	14
SECTION III. Operating Modes	16
Self-Diagnostic Mode	16
Surface Mode	17
Pre-dive Prediction Mode	19
CNS/OUT Toxicity Display	21
O ₂ Mix Display	22
Battery/Altitude Display	23
Logbook Mode	24
Subsurface Mode	26
Emergency Decompression Mode	28
Gauge Mode	31
SECTION III. EXPLANATIONS	33
Altitude Diving	33
Ascent Rate	34
Ascent Rate Bar Graph	34
BATT	35
Bottom	35
BP	35
Ceiling	35
Depth	36
Dive	37
Max Depth	37
Metric	37
Mission OTU Clock	37

Remaining Time Air	37
Remaining Time NDC	38
Remaining Time DEC	38
Surface Time	39
Tank	39
Temp	39
Time-To-Fly	39
AUDIBLE & VISUAL ALARMS	40
User Defined Maximum Depth	40
½ Tank Pressure Alarm	40
Low On Air	41
Ceiling Violation	41
Breathing Parameter	42
Ascent Rate Alarm	42
Low Battery Voltage	42
Gauge Mode Alarm	43
Two-Minute Warning	43
60-Foot Decompression Stop Warning	43
Entering Decompression Mode	43
Oxygen Tolerance Units (OTU) Warning	43
Central Nervous System (CNS) Oxygen Toxicity	44
Maximum PO ₂ Alarm	44
Data Storage Types & Capacity	45
User Configurable Options	45
Questions & Answers	49
SECTION IV. CARE AND MAINTENANCE	50
Rinsing and Cleaning	50
High-pressure Transducer Care	51
Battery Type and replacement	51
Battery Care	52
SECTION V. TECHNICAL SPECIFICATIONS	53
Replacement Parts	54
SECTION VI. ACCESSORIES	55
Field Programmer	55
Installation	56
Field Programming – NITROX Disabled	56
Field Programming – NITROX Enabled	59
Analyst [®] Personal Computer Interface	61

Introduction

Your NEMESIS[®]+ Dive Computer from Cochran Undersea Technology is one of the most advanced instruments made for this application. It incorporates more user-programmable functions than any other dive computer made, yet is one of the simplest to use. Once your personal preferences and perhaps some dive site or condition-specific settings are entered, its computing power goes to work in the background. What you, the diver, see is all the critical information you need, in an informative and easy to comprehend display, with minimal distraction.

With this manual, the basic operating information is presented first, followed by more technical and detailed sections for reference. Following are the sections you will find as you get acquainted with your NEMESIS[®]+. We hope you find this format helpful, informative, and readily absorbed. This manual is intended for use with the NEMESIS[®]+ with and without the Nitrox functions being enabled. Manual sections that apply to the Nitrox capabilities of the computer are in *Italic Type*.

- I. OVERVIEW. This section provides a brief look at several of the key functions and features of the NEMESIS[®]+
- II. INSTALLATION AND ACTIVATION. This section details the steps to ensure proper installation of your NEMESIS[®]+ to your regulator as well as providing information on how to activate your unit.
- III. OPERATING MODES. This section illustrates a typical display in each of the various operating modes of your dive computer, explains what is being shown, then makes reference to appropriate items in SECTION IV for more detailed explanations.
- IV. EXPLANATIONS. This section goes into much more detail on each function, how it relates to other information, and, where appropriate, what choices are available with regard to user programmable functions.

WARNINGS. A number of audible and visual warnings are generated by your NEMESIS[®]+ when circumstances warrant. The user may set many of these; this section explains their meanings and user choices.

QUESTIONS AND ANSWERS. We answer the most frequently asked questions about the NEMESIS[®]+ and its operation.
- V. CARE AND MAINTENANCE. This section details the basic maintenance and care necessary to assure optimum useful life from this device.
- VI. TECHNICAL SPECIFICATIONS. This section lists the technical specifications for your NEMESIS[®].
- VII. ACCESSORIES. This section contains the operational manual for the Field Programmer.

The NEMESIS[®] +: Overview

In addition to its standard time/depth-based decompression algorithm, the NEMESIS[®] + is one of the new breed of Dive Computers that adapts its algorithm to the user's diving environment and style as originally pioneered by COCHRAN. All of COCHRAN's newer dive computers incorporate this capability. The factors used for this 'Adaptation' in the NEMESIS[®] + are:

Altitude Acclimatization	Water Temperature
Salt/Fresh Water Compensation	Ascent Rate
User Conservatism	Previous Dive Profile
Workload	

However, the NEMESIS[®] + allows the diver, via the optional Analyst[®] PC Interface, to disable the Temperature and/or Workload decompression compensation should the diver deem a particular diving situation would so warrant. *Calculation of Central Nervous System Oxygen Toxicity (CNS), Mission Oxygen Tolerance Units (OTU's), and the Partial Pressure of Oxygen (PO₂)* is yet another added feature of this algorithm. Twelve half-time compartments ranging from 5 minute to 480-minute theoretical tissue groups are used. You will find that this unit is extremely user friendly and can be customized to your individual diving conditions and practices. Factors that influence the decompression algorithm of your NEMESIS[®] + are detailed below.

ALTITUDE ACCLIMATIZATION

Driving or flying to a dive site significantly higher in altitude requires special modifications to the "sea level" algorithm. The NEMESIS[®] + regularly samples the ambient barometric pressure to determine these changes in altitude. Accordingly, the decompression algorithm is changed to reflect these barometric pressure changes. Note that temperature and weather systems also affect barometric pressure and hence, apparent altitude. Using the Time-To-Fly digits, the number of hours required to "adapt" to the new altitude is immediately known to the diver. If a significant altitude change occurs, a minimum of one hour should pass before diving to allow the unit to adapt to this new altitude. Rapid changes in altitude should be avoided. The dive computer may in fact, see particularly rapid changes from a higher to a lower altitude as a dive. Should this occur, removing the batteries for ten minutes will reset the computer, however, all tissue nitrogen loading will also be lost.

Should it be desired to initiate a dive PRIOR to completing the adaptation time, the NEMESIS[®] + will treat this dive as a repetitive dive in its algorithm, taking into account the "residual" nitrogen present due to travel to altitude. There are two methods of compensating for altitude. Via the ANALYST[®] Personal Computer Interface, ZONE or SEAMLESS compensation for altitude may be selected.

In **ZONE** all altitudes less than 2,000 feet above sea level use the sea-level algorithm. At altitudes greater than this, altitude compensation is "seamless"; literally, every small fraction of gained altitude is considered in adjusting the algorithm. ZONE will reduce the occurrences of obtaining slightly different altitude readings and corresponding no-decompression (NDC) limits when diving within a

given area. However, ZONE reduces the accuracy of the altitude compensation for the first 2,000 feet above sea level, since all altitudes below 2,000 feet are treated as sea level. However, the advantage in ZONE is that changes in apparent altitude due to temperature or weather changes at sea level will not affect the NDC computations.

In **SEAMLESS**, the algorithm is adjusted for extremely small changes in altitude. However, a difference in altitude may be seen from day-to-day at a given dive site due to temperature or weather systems and their effect on barometric pressures. SEAMLESS will provide the most accurate altitude compensation algorithm, but normal variations in atmospheric barometric pressure may affect the no-decompression time which is more predominantly seen in the Pre-dive Prediction forecast.

WATER TEMPERATURE

Diving in cold water can lead to a lower diver core and skin temperature, which can affect the gas exchange rate of the body's tissues. The NEMESIS[®]+ progressively makes its' nitrogen algorithms more conservative as the water temperature declines below 75 degrees F. Above this water temperature, there is no temperature compensation. If the diver is wearing an insulated dry suit and is relatively warm even in cold water, this temperature compensation factor may be turned off at the divers discretion using the ANALYST[®] PC software.

ASCENT RATE

There are several theories regarding the exact method by which a nitrogen bubble forms from a microbubble which was formed from micronuclei. One predominant theory states that more rapid ascents accelerate bubble formation. The NEMESIS[®]+ attempts to compensate, or adapt, for these higher Ascent Rates. For Ascent Rates less than 30 feet-per-minute (fpm) there is no compensation. As the Ascent Rate goes progressively higher than 30 fpm the compensation progressively increases.

USER CONSERVATISM

Current dive computers cannot tell if the diver is dehydrated, tired, smokes, overweight, or has some other physical issue that may require additional conservatism in the nitrogen algorithm. The NEMESIS[®]+ allows the diver to input an added degree of conservatism to the nitrogen algorithm from 0 to 50 percent in one-percent increments. Field programming is featured.

PREVIOUS DIVE PROFILES

Under some circumstances, recent dive activity can have an effect on nitrogen loading, particularly if the diver engages in inverted profile diving. This occurs when

a deep dive is followed by an even deeper dive. This recent dive history is used to compensate the nitrogen loading for the current dive.

SEA WATER/FRESH WATER RECOGNITION

There is approximately three-percent difference in depth readings taken in fresh water versus seawater. Some dive computers are calibrated in feet of fresh water and some are calibrated in feet of salt water. Diving in a medium different from what the dive computer is calibrated will cause apparent depth errors. Only COCHRAN dive computers, including the NEMESIS[®]+, actually determine the type of diving medium and compensate the depth reading accordingly. This accomplished by measuring the conductivity of the water during a dive. Caution must be taken in interpreting this reading since some apparent fresh water is actually high in minerals or contaminants and is correctly compensated as salt water. This commonly occurs in some caves, springs and lakes.

WORKLOAD COMPENSATION

When a diver's work rate or exertion level increases, he consumes more breathing gas (air) and his Breathing Parameter (BP)/Surface Air Consumption (SAC) increases. The diver exchanges and retains higher levels of nitrogen in his tissues at a high work rate as compared to a low work rate. The NEMESIS[®]+ progressively makes its' nitrogen algorithms more conservative as work rate increases. The Workload Compensation starts when the diver's BP exceeds 35 psi per minute and reaches maximum compensation at 98 psi per minute. For accurate Workload Compensation the cylinder size, in liters, must be set correctly, this can be done by Field Programming or with the ANALYST[®] Personal Computer Interface. The Workload Compensation factor may be turned off at the divers discretion using the ANALYST[®] PC software.

Enriched Air Nitrox

Your NEMESIS®+ has the ability to provide the diver with the ability program the percentage of oxygen in the breathing mix from 21.0% to 50.0%. Using the included Field Programmer, you can set the oxygen percentage for the mix within that range.

Equivalent Air Depth

Your NEMESIS®+ uses Equivalent Air Depth (EAD) in determining the no-decompression limits for each individual dive. A standard NOAA equation is used to determine the EAD based upon the oxygen percentage entered. This equation is:

$$\text{EAD} = \frac{(1 - \text{O}_2\%) \times (\text{D} + 33)}{.79} - 33$$

Where O_2 is entered in decimal form and D is the actual depth in feet.

For example, if you were diving with NOAA II (36% oxygen) to 70 feet, the EAD used for determining your no-decompression limit would be:

$$\begin{aligned} \text{EAD} &= \frac{(1-.36) \times (70+33)}{.79} - 33 \\ &= \frac{.64 \times 103}{.79} - 33 = 50.44 \text{ feet} \end{aligned}$$

Therefore, the no-decompression time for this example would be calculated to an EAD of 50.44 feet.

Central Nervous System (CNS) Oxygen Toxicity

An additional consideration for the NITROX diver is Oxygen Toxicity. Your NEMESIS®+ will provide audible and visual warnings to alert you to this hazardous condition.

Maximum exposure time for a given depth is calculated based on the Partial Pressure of oxygen (PO_2). The following standard formula is used to determine the PO_2 :

$$\text{D} \times \text{O}_2\% = \text{PO}_2 \text{ level}$$

Where O_2 is entered in decimal form and D is the actual depth in atmospheres absolute.

For example, if you were diving to 86 feet with NOAA II your PO₂ level would be:

$$(86 + 33 \div 33) \text{ or } 3.61 \times .36 = 1.298$$

which would be rounded up to **PO₂ = 1.3**. PO₂ levels from 0.5 to 1.6 are calculated. Exceeding a PO₂ of 1.6 will greatly increase the probability of the immediate onset of CNS Oxygen Toxicity. While various training organizations have established maximum PO₂ limits, the maximum exposure times and their associated PO₂ levels used in this dive computer's calculations are shown on the following table:

PO₂ LEVEL	Max Bottom Time (minutes)
.5	1304
.6	719
.7	496
.8	379
.9	306
1.0	257
1.1	221
1.2	194
1.3	172
1.4	149
1.5	110
1.6	44

Your dive computer calculates CNS or OTU toxicity percentages and it issues a unique, five double-beep audible alarm once per minute should you reach 75 percent of the associated maximum limit. In addition to this audible warning, the WARNING legend will appear and flash AND the TEMPerature digits will be replaced with the current calculated CNS Oxygen Toxicity percentage. This warning will continue until the calculated toxicity percentage is less than 75 percent. For example, the maximum bottom time exposure for a PO₂ level of 1.6 is 44 minutes. Once you reached 33 minutes of bottom time with a PO₂ of 1.6, this alarm would be issued since 33 minutes is 75% of 44 minutes. At a PO₂ of 1.5, this alarm would be issued at 82.5 minutes, etc.

NOTE: While all other audible alarms of the dive computer consist of five long beeps, the toxicity audible alarm consists of short double-beeps that sound for five seconds.

WARNING: It is possible in certain diving circumstances to reach an Oxygen Toxicity limit well before reaching a no-decompression limit. For this reason, a diver who has successfully completed a sanctioned NITROX diving course from a recognized certifying agency should only conduct NITROX diving.

NOTE: By accepted definition of CNS Toxicity. Should a PO₂ value greater than 1.6 ATA be measured, the CNS Toxicity will be 100%.

Installation

The Tank Unit (TU) high-pressure sensor installs into a high-pressure port of your first-stage regulator. Your Authorized Dealer should do this at the time of purchase. Should you choose to install the TU yourself:

1. Remove your current high-pressure hose or the high-pressure plug from your first stage regulator.
2. Lightly lubricate the sensor o-ring only with a lubricant approved for use with Enriched Air Nitrox equipment. **DO NOT USE SILICONE GREASE.**
3. Screw the sensor, HAND TIGHT, into the first-stage high-pressure port
4. Using the supplied wrench, a Scuba Tool or thin 9/16" open-end wrench, "snug" the high-pressure transducer connection taking caution to not overtighten. **Do not** use pliers or too large a tool for tightening the high-pressure connection as you may damage the connection and is not covered under the limited warranty.

CAUTION: DO NOT use your hand to tighten the high-pressure connection. This procedure should only be accomplished by using the appropriate tool placed over the metal nut of the high-pressure connection. It must not be overtightened.

With the first stage properly attached to a filled SCUBA cylinder, slowly open the cylinder valve. Once the valve has been opened, listen to the TU's high-pressure connection for any escaping gas. If possible, completely immerse the tank and regulator in water to see if bubbles form around your connection. If any gas leak is seen or heard, immediately turn the gas off by closing the cylinder valve and take the entire regulator system to the place where you purchased your NEMESIS[®]+,

The Tank Unit (TU) clips to a low-pressure hose close to the first-stage, it is recommended that the TU be located on the divers left side. When clipping the TU onto the low-pressure hose, a rolling motion will provide better results rather than pushing the TU straight down onto the hose. The Wrist Unit (WU) may be worn on the wrist or attached to your Buoyancy Control Device with the optional retractor.

Activation

The TU will automatically activate when it senses a cylinder pressure greater than 200 psi or it may also be manually activated by tapping on the TU case in the circle area that says "PWR" for approximately three seconds. Should you choose this manual method of activation, it must be understood that the tapping should be performed in a manner that produces sound rather than vibration. When tapping, you should use your fingernail, coin, or other hard object that will produce sound when tapped against the TU case. In general, using your fingertip will not provide the necessary sound to successfully complete manual activation. The TU will issue five beeps as it begins its activation sequence.

NOTE: If the TU is in the Altitude Adaptation Mode or “sleeping”, four beeps instead of five beeps will be issued.

It is also required that the TU be no deeper than 3 feet of water in order to activate. Should you be deeper than three feet and attempt to activate the TU by using either cylinder pressure or manually via tapping, the TU will not turn on. You must ascend to the surface and re-initiate the activation sequence.

You cannot manually turn the TU off. The TU will turn off:

1. After 15 minutes if no tank pressure is sensed and no dive is made.
2. After all 12 half-time compartments are completely "off-gassed" on repetitive dives.

During an extended surface interval, the TU will enter a "sleep" mode to conserve battery life. After a dive, your NEMESIS®+ will enter its sleep mode after a surface interval of 40 minutes. During this sleep mode, all off-gassing calculations continue and current surface interval and time to fly can be viewed by activating the TU. Once awakened from its sleep mode, the TU will remain on for one hour before re-entering the sleep mode. This assumes, of course, that no repetitive dive is initiated between each wake-up.

The WU can be activated by rotating the wrist or tapping continuously on the lower left corner of the face of the unit for approximately five seconds or until the display becomes active. Since care has been taken to reduce the occurrence of the WU being accidentally activated during transport, the WU must be rotated or tapped for a longer period of time than is required to manually activate the TU. This same rotating or tapping action is used to select the alternate display. The alternate display is shown for three seconds before returning to the normal display. The TACLITE, the active backlighting for the WU display, is also activated whenever the alternate display is selected. TACLITE will remain illuminated for approximately 10 seconds.

Since all diving calculations are made by the TU, it is possible to activate the WU underwater should you mistakenly forget to do so prior to the dive. Once activated, the WU will immediately display the current diving data being calculated by your TU. During the dive, it is not possible to turn the WU off.

Once back on the surface, you can manually turn the WU off. This is recommended as a battery saving measure since all calculations are being performed by the TU. To turn the WU off on the surface, continuously tap the WU, in the same manner as that used to activate the unit, until the display goes blank. With a little practice, you will be able to tell just how many of your "taps" are required to turn the WU off.

OPERATING MODES

Self-Diagnostic Mode

At turn-on, both the TU and WU complete self-diagnostic tests before displaying current information. During these tests, all of the legends and digits on the WU illuminate for approximately five seconds. Upon completion, your computer displays its' WU serial number and then enters the Surface Mode.



Fig-1
Self-Diagnostic Mode

Explanation of Page Layouts

The following pages provide a "snapshot" of the screen displays for each of the computers various functional modes, showing:

1. An illustration of the WU display
2. The LEGEND displayed
3. The MEANING of that legend
4. The VALUE depicted under that legend
5. The PAGE where you may find more information on that particular function.

Any **WARNINGS** or **NOTES** about that mode will be displayed on this page.

Surface Mode

At the completion of the Self-Diagnostic Mode, the NEMESIS®+ enters the Surface Mode. The Surface Mode has two displays: a Primary Display and an Alternate Display. You may switch to the Alternate Display by rotating the wrist quickly or tapping firmly on the face of the WU. The Primary Display shows: DIVE number, time-to-FLY, TEMPerature, SURFace time, TANK pressure, and MAXimum DEPTH (of the last dive). The Alternate Display shows the last dives BOTTOM time, and breathing parameter (BP). The following sample displays are of the Surface Mode.

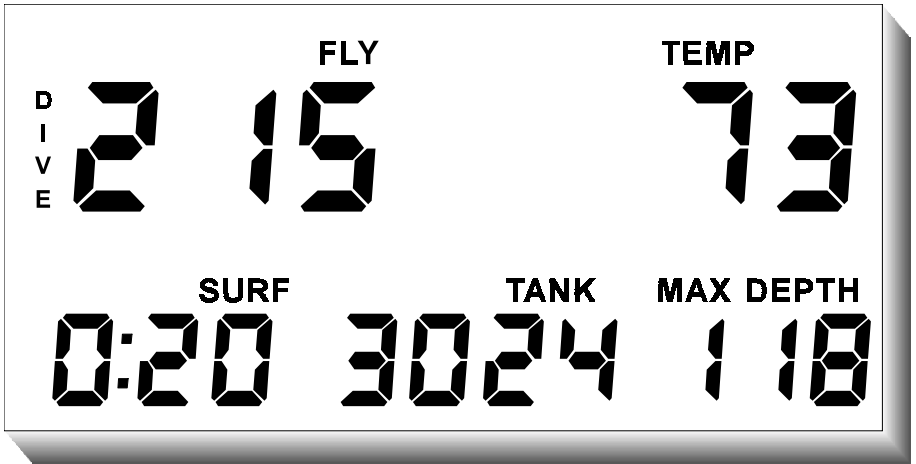

FIG-2
Primary Display

Approximately 10 seconds after powering up, your dive computer enters the Surface Mode.

<u>LEGEND</u>	<u>MEANING</u>	<u>VALUE SHOWN</u>	<u>PAGE</u>
DIVE	dive of the day	2	36
FLY	time-to-fly	15 hours	38
TEMP	present air temperature	73 deg. F	38
SURF	present surface time	0:20 minutes	38
TANK	current tank pressure	3024 psi	38
MAX DEPTH	maximum depth of previous dive	118 feet	36

Surface-Mode

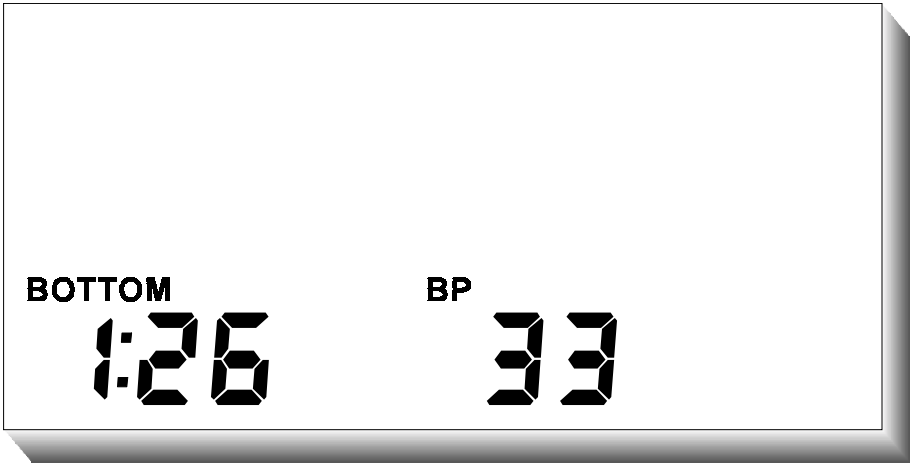

FIG-3
Alternate Display

<u>LEGEND</u>	<u>MEANING</u>	<u>VALUE SHOWN</u>	<u>PAGE</u>
BOTTOM	bottom time of last dive	1:26 (1hour 26 minutes)	34
BP	ending breathing parameter of last dive	33	34

Predive Prediction Mode

After one minute of Surface Mode, the NEMESIS®+ will automatically enter the Predive Prediction Mode. During this mode, predictions of no-decompression limits (NDC) or air time remaining (whichever is the lesser) will be made in ten foot increments beginning at 30 feet and ending at a depth having at least two minutes of NDC time available, up to a maximum predicted depth of 160 feet. The maximum depth predicted can be extended up to 320 feet in 10-foot increments via the optional Analyst® Personal Computer Interface. There is only a Primary Display in this mode. The WU will display the DEPTH, TANK pressure, and the lesser of the NDC (no-decompression time) or AIRtime remaining for that depth.



FIG-4
Primary Display

<u>LEGEND</u>	<u>MEANING</u>	<u>VALUE SHOWN</u>	<u>PAGE</u>
REMAIN TIME NDC	remaining NDC time	2:17(2 hours 17 minutes)	37
TANK	tank pressure	2176 psi	38
DEPTH	predicted depth	40 feet	35

NOTE: If the cylinder pressure is less than 500 psi at the time the predictions re being made, all predictions will reflect NDC times only.

NOTE: Predive predictions times that are based on AIRtime are calculated using the Breathing Parameter of the previous dive.

The following chart displays the beginning, sea-level no-decompression times for the depths from 30 to 160 feet for the U.S. Navy, DSAT, and the NEMESIS®+ based on air as the breathing gas.

Beginning NDC Limits

BEGINNING NO-DECOMPRESSION LIMITS(HOURS:MINUTES)				
DEPTH	U.S. NAVY	DSAT	NEMESIS®+	
30 FEET	—————		—————	2:22
40 FEET	3:20		2:20	2:17
50 FEET	1:40		1:20	1:18
60 FEET	1:00		:55	:56
70 FEET	:50		:40	:39
80 FEET	:40		:30	:30
90 FEET	:30		:25	:23
100 FEET	:25		:20	:18
110 FEET	:20		:16	:13
120 FEET	:15		:13	:11
130 FEET	:10		:10	:09
140 FEET	:10		:08	:08
150 FEET	:05		—————	:07
160 FEET	:05		—————	:06

NOTE: The Pre-dive Prediction NDC times observed may differ due to the effects of Altitude and, if the NITROX functions are enabled, the O₂ percentage that the unit is programmed for.

CNS/OTU Toxicity Display

At the conclusion of the PreDive Prediction Mode, your *NEMESIS*[®] + will display the current Central Nervous System (CNS) Toxicity and Oxygen Tolerance Unit (OTU) Toxicity levels. The CNS and OTU levels will be displayed in percent. This screen will be displayed for three seconds. There is only a Primary Display for this mode.



FIG-5
Primary Display

<u>LEGEND</u>	<u>MEANING</u>	<u>VALUE SHOWN</u>	<u>PAGE</u>
REMAIN TIME NDC	used to identify the CNS/OTU Toxicity Display	2:00	37
TANK	indicates the CNS Toxicity percentage.	27%	38
DEPTH	indicates the OTU Toxicity level percentage.	8%	35

O₂ Mix Display

Following the CNS/OTU Toxicity Percentage Display, the current oxygen percentage for the Nitrox Mix is displayed as a factor of 10. For example, an oxygen percentage of 35.5 would be displayed as 355.

The Nitrox Mix percentage will be displayed under the TANK legend. This mode has only a Primary Display and is displayed for three seconds.



FIG-6
Primary Display

<u>LEGEND</u>	<u>MEANING</u>	<u>VALUE SHOWN</u>	<u>PAGE</u>
REMAIN TIME NDC	used to identify the O ₂ Mix Display	1:00	37
TANK	Indicates the O ₂ percentage times 10.	32.0%	38
DEPTH	Disregard	00.0	

Your dive computer has the ability to be programmed for O₂ percentages in 1/10 of a percent increment via the Field Programmer, or the optional Analyst[®] Personal Computer Interface. The WU displays these values as whole numbers. Therefore 28.7% O₂ would be displayed as 287 on the WU.

Battery/Altitude Display

The two digits under the DEPTH legend indicate the current TU battery voltage as a factor of 10. For example if the TU's battery voltage were 5.8 volts, the two digits under the DEPTH legend would display 58.

The numbers under the TANK legend display altitude in 1000-foot increments. For example, if under the TANK legend you see 4, the altitude calculated would be 4000 feet above sea level (4 X 1000 = 4000).

At the end of the 3-second display, the unit returns to Surface Mode. There is only a Primary Display for this mode.

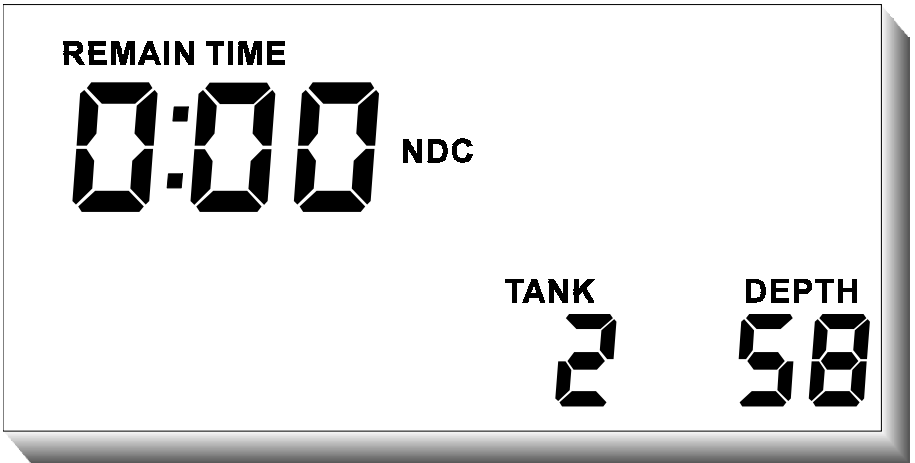

FIG-7
Primary Display

<u>LEGEND</u>	<u>MEANING</u>	<u>VALUE SHOWN</u>	<u>PAGE</u>
REMAIN TIME NDC	used to identify the Battery/Altitude Display	0:00	37
TANK	altitude	2000 feet above sea level	38
DEPTH	battery voltage	5.8 volts	35

WARNING: While your NEMESIS®+ will automatically adjust its no-decompression algorithm for altitude, you should NOT attempt to dive at altitudes greater than 1,000 feet above sea level without first completing a sanctioned altitude diving course from a recognized training agency for recreational diving. A NEMESIS®+ should not be used by anyone without this important training.

Logbook Mode

While your **Nemesis®+** is in its normal Surface Mode, you can access the Logbook Mode. To do this, tap the crosshatched area labeled "PWR" on the TU. This will cause the display to change on the WU to the Logbook Mode. A feature of your **NEMESIS®+** is its ability to provide diving data to you in this mode for your previous 300 dives beginning with your most recent dive. To move to the next prior dive, tap the PWR area of the TU again. Wait for the new data to be displayed on the WU before tapping again to go to the next prior dive. Access the WU's Alternate Display by tapping or rotating the WU until the display appears. It will appear for three seconds before returning to the Logbook Mode's Primary Display. Your **NEMESIS®+** will return to the Surface Mode thirty seconds after the final selected log has been displayed. The information contained on the Logbook Mode's Primary Display includes: DIVE number, time-to-FLY, ASCENT rate, TEMPERATURE, BOTTOM time, TANK pressure, and MAXIMUM DEPTH. The Alternate Display shows: REMAINING time, CEILING, BP, and DEPTH.

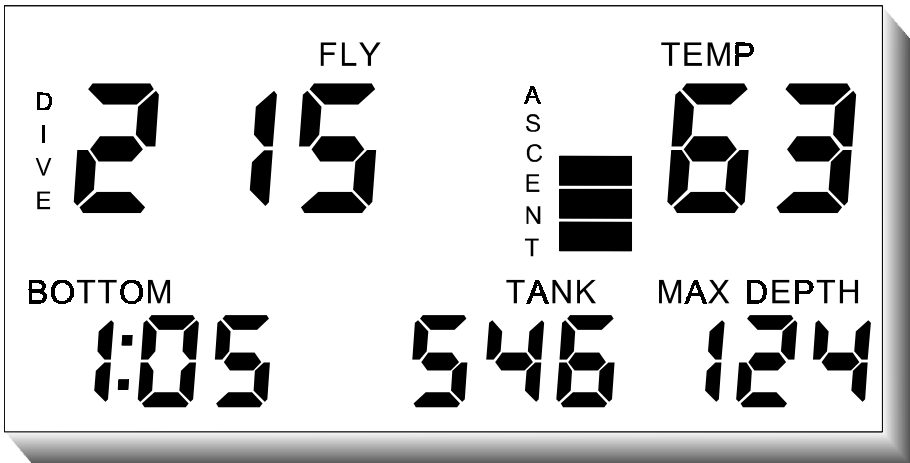

FIG-13
Primary Display

<u>LEGEND</u>	<u>MEANING</u>	<u>VALUE SHOWN</u>	<u>PAGE</u>
DIVE	dive of the day number	2	36
FLY	waiting period before flying.	15 hours	38
ASCENT	the maximum ascent rate during the dive.	31-40 feet / minute*	32
TEMP	average water temperature of the dive	63 deg. F	38

BOTTOM	duration of the dive	1:05 (1 hour 05 minutes)	34
TANK	ending tank pressure	546 psi	38
MAX DEPTH	maximum depth of the dive	124 feet	36

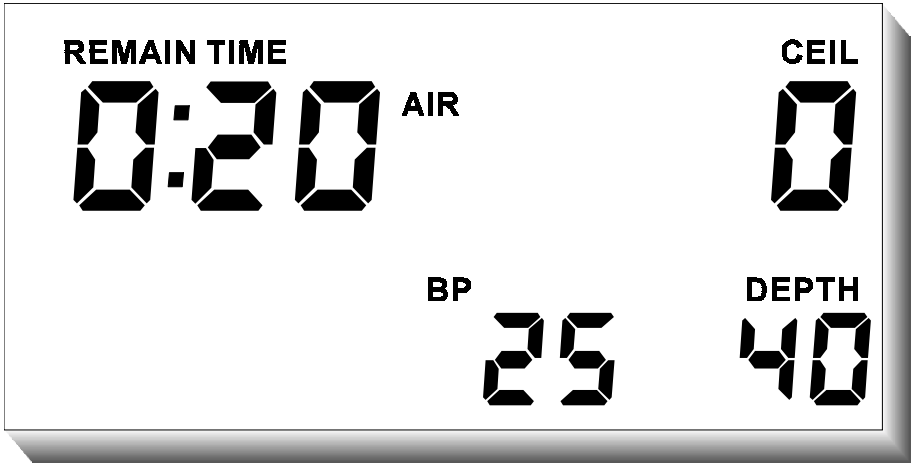

FIG-14
Alternate Display

<u>LEGEND</u>	<u>MEANING</u>	<u>VALUE SHOWN</u>	<u>PAGE</u>
REMAIN TIME AIR	the minimum calculation of either NDC, AIR or the total decompression time recorded for this dive.	0:20 (20 minutes)	36
CEIL	maximum ceiling stop required	0 feet	35
BP	average breathing parameter for dive	25	34
DEPTH	average depth of dive	40 feet	35

Subsurface Mode

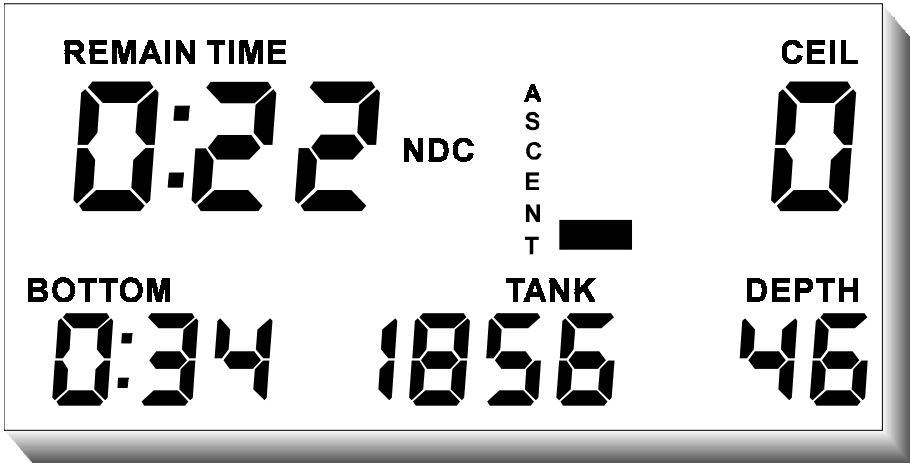

FIG-8
Primary Display

The Subsurface Mode activates when the dive computer senses a depth greater than five feet and is exited when the dive computer senses a depth less than three feet.

<u>LEGEND</u>	<u>MEANING</u>	<u>VALUE SHOWN</u>	<u>PAGE</u>
REMAIN TIME AIR or REMAIN TIME NDC	lesser of the two	0:22 (22 minutes of remaining NDC time)	36
ASCENT	rate at which you are ascending	11-20 feet per minute	32
CEIL	ceiling stop required (if any)	0 feet	35
BOTTOM	bottom time	0:34 (34 minutes)	34
TANK	current tank pressure	1856 psi	38
DEPTH	current depth	46 feet	35

The Subsurface Mode has a Primary and an Alternate display. The Primary Display shows the REMAINING TIME for either AIR or NDC, whichever is less, CEILING, BOTTOM time for this dive, current TANK pressure, current DEPTH, and ASCENT rate.

The Alternate Display Shows: REMAINING TIME for either AIR or NDC, whichever is greater; TEMPerature, BP, and MAXimum DEPTH of this dive. When accessed the Alternate Display is seen for three seconds.

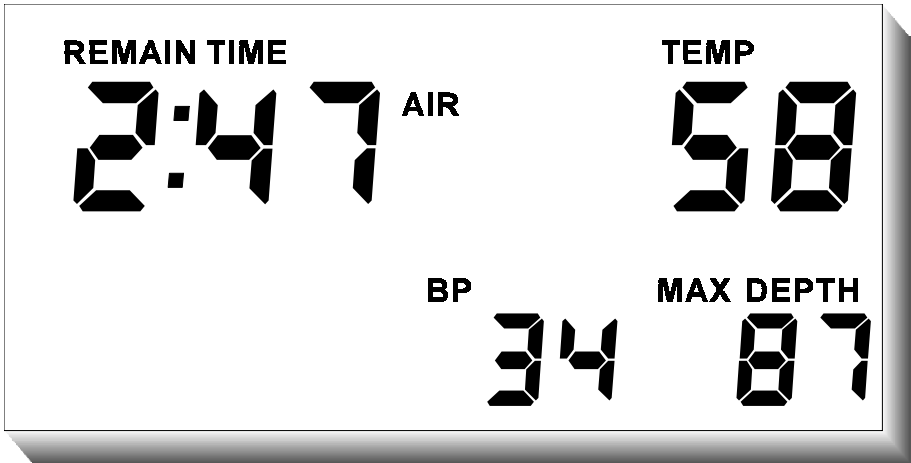

FIG-9
Alternate Display

<u>LEGEND</u>	<u>MEANING</u>	<u>VALUE SHOWN</u>	<u>PAGE</u>
REMAIN TIME AIR or REMAIN TIME NDC	greater of the two	2:47 (2hours 47 minutes of remaining AIR time)	36
TEMP	current temperature	58 deg. F	38
BP	current breathing parameter	34	34
MAX DEPTH	maximum recorded depth	87 feet	36

Emergency Decompression Mode

WARNING: Your NEMESIS[®]+ should not be used for deliberate decompression diving, but merely as an aid to assist you during ascent should you mistakenly overstay your no-decompression limit. Cochran Undersea Technology in no way encourages deliberate decompression diving.

Should you exceed your NDC time limit, your NEMESIS[®]+ will enter its Emergency Decompression Mode. Five audible warning chirps will sound and the DEC legend will appear on your WU. Decompression ceilings up to 90 feet are calculated. An additional five chirp audible warning will sound if a decompression ceiling greater than 60 feet is calculated.

WARNING: You should IMMEDIATELY begin your ascent to the proper CEILING depth upon hearing these warnings.

Your NEMESIS[®]+ is configured at the factory to alternate between total decompression time for three seconds and time at current stop for three seconds. Via the optional Analyst[®] Personal Computer Interface, you can select to have only total decompression time or stop time displayed if you so desire.

CEILING is the depth to which you must ascend, BUT NOT EXCEED, for your first emergency decompression stop. The WU display will indicate the various ceiling stop depths as follows:

Ceiling Calculated	Ceiling Displayed
10 foot	10
20 foot	20
30 foot	30
40 foot	40
50 foot	50
60 foot	60
70 foot	7
80 foot	8
90 foot	9

NOTE: When completing your decompression stops, minor changes in your depth may occur due to swells at the surface. For this reason, you should make your stop slightly deeper than the CEILING depth. Your Nemesis[®]+ will continue to give decompression credit when this precaution is taken.

Time spent above a CEILING depth will not be credited to the required decompression obligation. Instead, a 1.5-second penalty will be added to that time for each one second spent above the CEILING.

CAUTION: Ascending above the CEILING depth will cause your NEMESIS[®]+ to issue a warning chirp. The current depth digits and the WARNING legend will flash. Both the audible alarm and the flashing display will continue until you descend below the CEILING depth.

Your BOTTOM time, TANK pressure, ASCENT rate, and DEPTH gauge will continue to operate normally as if you were in the Subsurface Mode.

Emergency Decompression Mode



**FIG-10
Primary Display**

Should a diver enter the Emergency Decompression Mode, the following information is shown on the Primary Display.

<u>LEGEND</u>	<u>MEANING</u>	<u>VALUE SHOWN</u>	<u>PAGE</u>
REMAIN TIME DEC	amount of time remaining at this CEILing. *	0:15 (15 minutes)	37
CEILING	depth which you MUST NOT ascend above.	20 feet	35
BOTTOM	total bottom time	1:56 (1hour 56 minutes)	34
TANK	current tank pressure	1654 psi	38
DEPTH	current depth	25 feet	35

* This value is dependent upon how the dive computer is configured. If BOTH is selected, then this value could mean the total decompression time left. See section regarding REMAIN TIME DEC for more information.

Emergency Decompression Mode

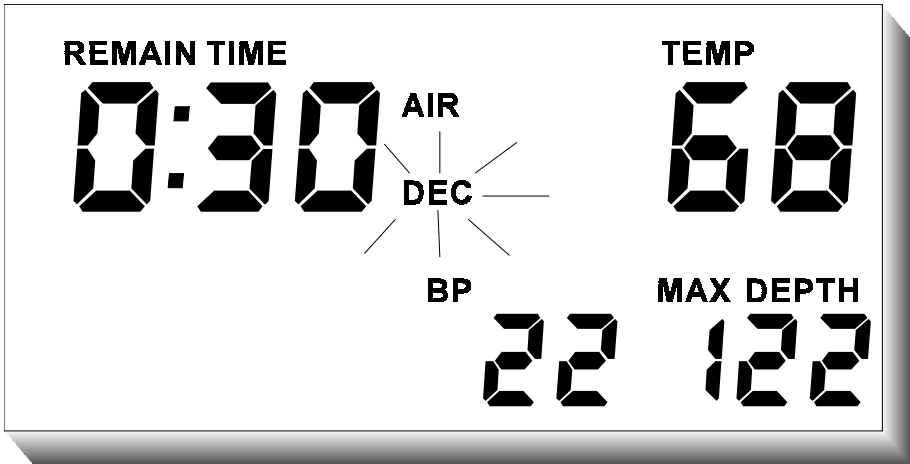

FIG-11
Alternate Display

The following information is provided on the Alternate Display while in Emergency Decompression Mode.

<u>LEGEND</u>	<u>MEANING</u>	<u>VALUE SHOWN</u>	<u>PAGE</u>
REMAIN TIME AIR	remaining air time	0:30 (30 minutes)	36
TEMP	water temperature	68 deg. F	38
BP	breathing parameter	22	34
MAX DEPTH	greatest depth reached on this dive	122 feet	36

Gauge Mode

Violating certain conditions will cause your dive computer to cease providing remaining time information and stop calculating nitrogen absorption/elimination. When this occurs, your unit has entered its Gauge Mode. **Once in this mode, 24 hours of surface time MUST elapse without a dive being made before the system will resume its normal operation.**

Any one of the following conditions will cause your dive computer to immediately enter Gauge Mode:

- More than five minutes elapsed with the depth less than the CEILING.
- A CEILING depth greater than 90 feet is calculated
- The maximum functional operating depth of 327 feet is exceeded.

EXCEEDING THE CEILING DEPTH:

If you ascend to a depth shallower than the Ceiling depth when in the Emergency Decompression Mode, the dive computer will issue its chirp alarm continuously and flash the WARNING legend and the DEPTH digits once a second until you descend back below the CEILING. If five minutes elapse without this violation being corrected, the dive computer enters its Gauge Mode.

EXCEEDING A 90 FOOT CEILING STOP:

A Ceiling depth of greater than 60 feet will only occur if you grossly overstay your no-decompression limit. The second that your dive computer calculates that a Ceiling of greater than 60 feet is required, it will immediately issue its five-second-chirp alarm. If the unit determines that you require a ceiling stop greater than 90 feet, the unit will issue five audible warning chirps and enter Gauge Mode.

EXCEEDING THE MAXIMUM OPERATING RANGE:

The dive computer will continue to operate as long as you DO NOT descend below 327 feet. Descending below 327 feet will cause the dive computer to issue its five-second-chirp alarm and enter Gauge Mode.

NOTE: Exceeding the maximum operating range of the NEMESIS®+ will void the limited warranty.

In Gauge Mode, your dive computer will continue to display DEPTH (if it is 327 feet or less), TEMPerature, BOTTOM time, ASCENT rate, and TANK pressure.

WARNING: You should wait a minimum of 24 hours before flying or making another dive if your unit has entered Gauge Mode. Failing to do so will greatly increase your risk of Decompression Sickness.

Gauge Mode

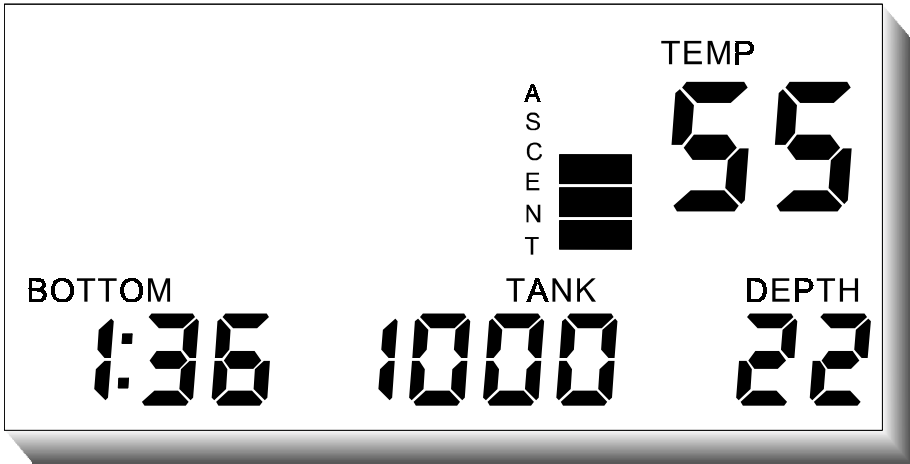

FIG-12
Primary Display

NOTE: Only one display is available when in Gauge Mode.

<u>LEGEND</u>	<u>MEANING</u>	<u>VALUE SHOWN</u>	<u>PAGE</u>
TEMP	water temperature	55 degrees F	38
ASCENT	rate at which you are ascending	31-40 feet per minute	32
BOTTOM or SURF	current time either on surface or submerged depending on if you are underwater	1:36 (3 hours 36 minutes)	34 38
TANK	tank pressure	1000 psi	38
DEPTH	current depth	22 feet	35

SECTION III EXPLANATIONS

DESCRIPTION OF FUNCTIONS

Altitude Diving

Your NEMESIS®+ senses the barometric pressure for altitudes up to 15,000 feet above sea level. Barometric pressures at a given altitude can change due to high and low-pressure weather systems as well as temperature.

When compared with most analog depth gauges at altitude, NEMESIS®+ will display a greater depth. This is due to the reduced atmospheric pressure at the surface. Your NEMESIS®+ is no substitute for the completion of a sanctioned altitude diving course from an international recognized certifying agency. The NEMESIS®+ will only provide information that will allow the trained altitude diver to make safe diving decisions. Greater care should be taken when diving at altitude to avoid extending no-decompression times to their maximum limits.

WARNING: Diving at altitude requires a slower rate of ascent as well. Your NEMESIS®+ will continue to display your rate of ascent as usual, but rates slower than 60 feet per minute should be used. Your certifying agency in altitude diving will provide you with their current recommended rates.

Ascent Rate

Subsurface Mode, Emergency Decompression Mode, or Gauge Mode:

Ascent rate is averaged over a running four-second period. For purposes of the description, this manual will just refer to ascent rate with the reader understanding that this is a four-second averaged ascent rate and not an instantaneous ascent rate.

You can also select between a Fixed or Variable Ascent Rate with the optional Analyst® Personal Computer Interface.

FIXED: In the fixed mode, the ascent rate will be fixed throughout the entire dive profile regardless of depth. The fixed rate set at the factory is 60 feet per minute. With this default setting, your computer will alarm if you exceed an ascent rate of 60 feet per minute.

The diver may select fixed rates from 20 to 60 feet per minute.

VARIABLE ASCENT RATE: This feature utilizes several different ascent rates that are depth dependent. At depths greater than 60 feet, the maximum allowable ascent rate is set to 60 feet per minute. At depths less than 30 feet, the maximum allowable ascent rate is set to 30 feet per minute. From depths between 30 and 60 feet, the maximum allowable ascent rate will be the same as the current depth. For example, when you are at 43 feet, the maximum allowable ascent rate is 43 feet per minute.

Logbook Mode: The maximum speed of ascent recorded on the dive is displayed.

Note: Ascent rate is only computed and displayed at depths greater than 10 feet.

Ascent Rate Bar Graph

The Ascent Rate Bar Graph is comprised of a vertical five-segment bar. With the optional Analyst® Personal Computer Interface, you can select this bar graph to either represent the rate (speed) of your ascent or a percentage of the selected maximum ascent rate.

SPEED: With this option, each bar of the graph represents an additional 10 feet per minute of speed. For example, if you were ascending between 11 and 20 feet per minute, one bar segment would illuminate. If you were ascending between 21 and 30 feet per minute, two bar segments would illuminate, and so on with all five bar segments appearing when ascending between 51 and 60 feet per minute. The performance of this option remains the same regardless of the type or the maximum ascent rate selected.

PERCENTAGE: With this option, each bar of the graph represents an additional 20% of the maximum ascent rate selected. For example, if you had selected a fixed ascent rate limit of 30 feet per minute, each bar segment would represent an additional ascent rate of 6 feet per minute. (6 is 20% of 30) This option is especially useful if a variable ascent rate is selected. Regardless of the depth and associated maximum ascent rate, you will quickly be able to identify if you are approaching 100% maximum limit.

The Ascent Rate Bar Graph is set at the factory to display SPEED.

**GREATER THAN 60 FEET
PER MINUTE WARNING AND
TOP BAR OF GRAPH WILL FLASH**

WARNING







A		50 TO 60 FEET PER MINUTE
S		40 TO 49 FEET PER MINUTE
C		30 TO 39 FEET PER MINUTE
E		20 TO 29 FEET PER MINUTE
N		10 TO 19 FEET PER MINUTE
T		10 TO 19 FEET PER MINUTE

Fig-21 ASCENT RATE BAR GRAPH (Fixed at 60 feet-per-minute)

Batt

This legend is illuminated when either the battery in the TU or WU is low. If this legend is flashing, then the battery in the TU is low. If the legend is on steady, then the battery in the WU is low.

NOTE: If both batteries are low, then the BATT legend will flash. Upon replacement of the TU's batteries, the BATT legend will then be on steady indicating that the WU's batteries do need to be replaced.

Bottom

This is the total bottom time (displayed in hours and minutes) calculated for a particular dive. Should a diver ascend to the surface, remain on the surface for less than 10 minutes and then commence another dive, the bottom time will continue to increment as though there was no time spent on the surface.

Surface Mode: The bottom time of your last dive is provided to you on the Alternate Display in hours and minutes. At the start of a new dive day, the bottom time will be 0:00.

Logbook Mode: The bottom time for the profile viewed is displayed on the Primary display.

Subsurface Mode or Emergency Decompression Mode or Gauge Mode: Your dive computer begins to count your bottom time when you have descended below five feet. Bottom time continues to be counted until you have ascended above three feet. This time is expressed in hours and minutes.

BP

Breathing Parameter (BP) is a measure of your breathing efficiency. The more you dive, the more efficient your breathing becomes. With your dive computer, you will be able to monitor and log your progress. The number displayed is the amount of air you breathe per minute in psi normalized to the surface (one atmosphere). This data is sometimes referred to as Surface Air Consumption (SAC). Since Breathing Parameter is a "parameter", it remains in psi per minute regardless of metric or imperial calculations. Via the optional Analyst[®] Personal Computer Interface, you can also select Breathing Parameter to display liters per minute.

By eliminating depth as a variable, you will easily be able to compare your breathing rate from depth to depth and dive to dive. As you know, the amount of actual air you breathe per minute varies proportionate with depth even if your breathing rate remains unchanged. By normalizing your breathing rate to the surface, an immediate comparison of the rates can be made. For example, let's say that you made two dives, the first to 99 feet and the second to 66 feet. Lets also assume that your breathing rate was the same on both dives; and using the previous example, lets say your BP displayed 23, indicating your breathing rate as 23 psi per minute normalized to the surface. If depth entered the equation, your 99 foot dive would display a BP of 92 ($23 \times 4\text{ATM's} = 92$) while the dive to 66 feet would display a BP of 69 ($23 \times 3\text{ATM's} = 69$). With your dive computer, you can immediately see that your rate

remained unchanged from the first to second dive. If the actual psi per minute breathed at depth was displayed, you would have seen two very different numbers, 92 and 69, and you would then have to calculate further to achieve a comparison.

Since BP is computed by monitoring the drop in tank pressure, a larger volume tank will show a more efficient BP while the BP of a smaller tank will be less efficient. For normal, casual sport SCUBA diving on a 10-litre (80 cubic foot tank), a BP of between 18 and 35 is considered normal. Breathing Parameter is computed and updated only at depths below ten feet.

Subsurface Mode: The averaged Breathing Parameter for the dive in progress is displayed.

Logbook Mode: The average BP for the profile view is provided.

Ceiling

Logbook Mode: This will show whether or not the dive profile viewed was a no-decompression dive. If you entered Emergency Decompression Mode on that particular dive, the CEILING would display the deepest stop that was required.

Emergency Decompression Mode: The depth above which you must not ascend when in the Emergency Decompression Mode.

Subsurface Mode: When making a no-decompression dive, the CEILING should read 0 indicating that you may make a direct ascent to the surface without completing any decompression stops. Should you enter into a decompression situation, the CEILING will indicate, in feet or meters, the depth to which you must ascend and complete a Decompression Stop.

Depth

Subsurface Mode: The numbers under the DEPTH legend are used to display the current depth. Your dive computer has the intelligence to automatically determine if you are diving in fresh or seawater thereby providing you with the actual depth for the type of water in which you are diving.

Emergency Decompression Mode: The numbers under the DEPTH legend are used to display the current depth.

Gauge Mode: The numbers under the DEPTH legend are used to display the current depth.

Predive Prediction Mode: In this mode, the digits under the DEPTH legend indicate the depth associated with the displayed NDC prediction.

Logbook Mode: The numbers under the DEPTH legend are used to display the average depth of the dive.

CNS/OTU Toxicity Display: On this display, the numbers under the DEPTH legend are used to display the OTU Toxicity percentage.

Battery/Altitude Display: The two digits under the DEPTH legend will indicate the TU's current battery voltage as a factor of ten. For example, if the TU's battery voltage were 5.8 volts, the two digits under the DEPTH legend would display 58. If the battery voltage were 5.3 volts, the two digits under the DEPTH legend would be 53.

Dive

Surface Mode: The dive number counts the number of dives made in a single "dive day". This counter begins with 0 and continues through 9, resetting back to 0 each time the TU is powered on.

Logbook Mode: The dive number in the Logbook Mode will identify which dive of that particular "dive day" you are viewing. For example, if you had just made your third dive of the day, the dive number would display 3 for the first profile viewed. The next would display 2, and the next would display 1. The next would display the last dive's DIVE number from the previous day. If you only made two dives on that previous day, the DIVE number would display 2 and so on.

NOTE: A "dive day" is defined as from the time you turn the TU on and lasting until all twelve half-time compartments reach normal levels. For this reason, you may have more than one "dive day" within a single 24-hour period or a "dive day" may last for more than 24 hours.

Max Depth

Surface Mode: After your dive, the maximum depth reached on that dive will be displayed up to the maximum gauge depth of 327 feet.

Logbook Mode: The maximum depth recorded on the profile viewed is displayed.

Subsurface Mode: This is the maximum depth recorded during the dive.

Metric

This legend indicates that the dive computer is set to calculate and display altitude, depth, and tank pressure values in the METRIC mode. Altitude and Depth will be calculated in meters. Tank pressure will be calculated and displayed in either BAR or Kg/cm². You may select the metric display via the optional Analyst[®] Personal Computer Interface.

Mission OTU Clock

This is a running clock that tracks your long-term risk to Oxygen Toxicity. This clock may run for several weeks. The Mission OTU Clock is reset to 0:00 when the OTU level is also 0.

Remain Time Air

Pre-dive Prediction Mode: When tank pressure greater than 500 psi is present on the computer's high pressure transducer, the lesser of either remaining airtime or the predicted no-decompression time is displayed for each depth.

Subsurface Mode: The display on which this data appears is dependent on whether the remaining airtime is greater or less than the remaining no-decompression. If the remaining airtime is less than the remaining no-decompression time, it will appear on the Primary Display along with the AIR legend. If the remaining airtime is greater than the remaining no-decompression time, it will appear on the Alternate Display along with the AIR legend.

Emergency Decompression Mode: The remaining airtime is always displayed on the Alternate Display.

Logbook Mode: If during the profile being displayed, the minimum recorded remaining time data was remaining airtime, the Alternate Display will display this data under the REMAIN TIME legend.

Remain Time NDC

Predive Prediction Mode: When tank pressure greater than 500 psi is present on the computer's high pressure transducer, the lesser of either remaining airtime or the predicted no-decompression time is displayed for each depth. If there is less than 500 psi present on the computer's high-pressure transducer, all predive predictions will be made using only no-decompression times.

NOTE: If the no-decompression limit for a given depth is less than two minutes, your dive computer will not make a predive prediction for that depth.

Logbook Mode: If during the profile being displayed, the minimum recorded remaining time data was remaining no-decompression time, the Alternate Display will display this data under the REMAIN TIME legend.

Subsurface Mode: This is the amount of no-decompression time remaining displayed in hours and minutes.

CNS/OTU Toxicity Display: The number 2:00 under the REMAIN TIME legend is used to indicate the CNS/OTU Toxicity Display.

O2 Mix Display: The number 1:00 under the REMAIN TIME legend is used to indicate the O2 Mix Display.

Battery/Altitude Display: The number 0:00 under the REMAIN TIME legend is used to indicate the Battery/Altitude Display.

Remain Time DEC

Emergency Decompression Mode: The time displayed will be dependent upon how the dive computer has been setup. The information displayed will be either:

- Total time to complete all required decompression - or -
- Time Remaining at each individual stop - or -
- Alternating between total and stop time.

If the alternating option is selected, each time is displayed for 3 seconds.

Logbook Mode: If you are viewing an Emergency Decompression dive, the total required decompression time would be displayed followed by the DEC legend.

Surface Time

Surface Mode or *Gauge Mode*: Surface time is displayed in hours and minutes from the time the TU is turned on or at the end of a dive when ascending above three feet. Surface times from 0:00 to 17:03 will be displayed.

Tank

Surface Mode, *Subsurface Mode*, *Emergency Decompression Mode*, or *Gauge Mode*: The numbers under the TANK legend are used to display the current tank pressure in one-psi increments.

PreDive Prediction Mode: If the amount of air remaining in your tank allows five minutes or less of bottom time for a given depth during the PreDive Prediction Mode, the tank digits will flash. This flashing will only occur for the predicted depths, which apply.

Logbook Mode: During the first three seconds of display, the accumulative dive number is shown, then replaced by the ending tank pressure for the dive profile viewed.

CNS/OTU Toxicity Display: The numbers under the TANK legend indicate the current CNS Toxicity percentage.

O2 Mix Display: On this display the number under the DEPTH legend is used to display the user programmed percentage of oxygen in the breathing mix. This value is displayed as a factor of 10. For example an oxygen percentage of 21.5 percent would be displayed as 215.

Battery/Altitude Display: In the Battery/Altitude Display, the number under the TANK legend are used to display altitude rounded to the nearest thousands of feet above sea level. For example, if under the TANK legend you see 4, the altitude calculated would be between 3600 feet and 4500 feet

Temp

Surface Mode: The current temperature that is calculated by the TU will be displayed.

Subsurface Mode: This is the water temperature calculated by the TU.

Logbook Mode: This is the average water temperature recorded for the viewed profile

Time-To-Fly

Surface Mode: If you plan to fly after diving, you must first allow time for your body to eliminate all of the residual nitrogen it has absorbed from diving. Your dive computer calculates this for you and displays the hours you must wait before safely flying or traveling to altitude after diving. The time calculated includes an additional 12-hour surface time for added safety. For example, if it would take your body three hours to eliminate all residual nitrogen, the time-to-FLY would display 15 hours (three hours plus the 12 hour added safety margin).

Logbook Mode: In the Logbook Mode, the time-to-FLY calculated at the end of that particular dive profile is displayed.

CAUTION: It is always recommended that you wait at least 24 hours before flying after diving.

AUDIBLE & VISUAL WARNINGS

In this chapter you will learn to recognize the audible and visual warnings that your dive computer may issue to alert you of a potentially hazardous condition.

User Defined Maximum Depth

Using the included Field Programming Unit you have the ability to define a maximum depth to which you wish to dive. The depth may be set from 0 to 327 feet in 1-foot increments. Refer to the Field Programming section of this manual. You may also set this depth via the optional Analyst[®] Personal Computer Interface. Should you descend to a depth deeper than your selected maximum depth, the DEPTH digits will flash and once every minute, the five-chirp audible alarm will sound. The factory setting for this warning is 130 feet.

NOTE: The Depth Alarm is disabled during the Emergency Decompression Mode.

1/2 Tank Pressure Alarm

When you have consumed one-half of the cylinder's "usable" pressure, your dive computer will issue a one time five-chirp audible alarm. If you use all of the "usable" tank pressure, you will still have a safety reserve of 500 psi. The point at which the 1/2 Tank Pressure Alarm will sound is easily determined by using the following formula:

$$TP \text{ --- } \frac{(TP - 500)}{2} = \text{1/2 Tank Pressure Alarm limit}$$

Where: TP = beginning tank pressure

For example, let us say you started your dive with a tank pressure of 2500 psi.

$$2500 \text{ --- } \frac{(2500 - 500)}{2} = 1500 \text{ psi}$$

The 1/2 Tank Pressure Alarm would sound at 1500 psi. This warning is disabled when shipped from the factory. You can enable this option via the Analyst®.

Low On Air

Should you approach 500 psi of pressure remaining in your SCUBA tank or five minutes or less of remaining airtime, your dive computer will:

Issue a one time, five-chirp audible warning - and
Flash both the WARNING legend and the TANK digits

If you should ever have less than five minutes of remaining airtime, your dive computer will also illuminate the AIR legend on the WU.

The flashing of the WARNING legend and the digits under the TANK legend will continue until the airtime Remaining is increased to at least ten minutes. This may be accomplished by ascending to a shallower depth. This is not a settable alarm.

If you are in the Emergency Decompression Mode and the remaining airtime is either equal to or is less than the total decompression obligation, both the AIR and DEC legends will appear. Remaining Decompression Time is ALWAYS shown on the Primary Display while the Remaining airtime in this mode is ALWAYS displayed on the Alternate Display. On the Primary Display, the AIR legend will flash while on the Alternate Display, the DEC legend will flash.

NOTE: See the section of this manual regarding the Emergency Decompression Mode for more information.

Ceiling Violation

When in the Emergency Decompression Mode, ascending to a depth shallower than the Ceiling depth will cause your dive computer to:

Flash the WARNING legend and the depth digits and
Continuously sound its audible chirp alarm.

This is not a settable alarm.

NOTE: You will receive a 1.5-second penalty for each second you remain above your CEILING. If you remain in a CEILING violation condition for more than five minutes, your dive computer will enter its Gauge Mode.

Breathing Parameter Alarm

Using the optional Analyst[®] Personal Computer Interface, you may enter predefined high and low limits for Breathing Parameter. If your Breathing Parameter is greater than your high limit or less than your low limit, your dive computer will issue a five beep alarm once each minute until your Breathing Parameter is back with the decided range. This feature is disabled at the factory and can only be enabled via the Analyst[®] Personal Computer Interface.

Ascent Rate Alarm

Your dive computer allows the user to select either fixed or variable Ascent Rate warnings. See the description of Ascent Rate under the EXPLANATION OF FUNCTIONS section for a description of fixed and variable ascent rates.

If you exceed the maximum ascent rate, your dive computer will:

Flash both the WARNING legend and
Sound its audible alarm once every second.

The sound of this audible alarm is unique. Rather than a low-to-high "sweep" in sound, the Ascent Rate Alarm is a high-to-low "sweep".

Low Battery Voltage

Standard, user-replaceable batteries power both the TU and WU. The TU is powered by four, size-AA alkaline batteries and the WU by two size-N alkaline batteries. Should the WU's battery voltage become low, the BATT legend on the WU will illuminate. When the TU's batteries become low, the BATT legend on the WU will flash and the TU will issue a one time five-chirp audible warning. The batteries should be replaced as soon as possible after the low battery indicators appears.

WARNING: Properly replacing the batteries from the TU will not cause your dive computer to lose current nitrogen absorption and elimination data for the most recent dive or dive series. See the section regarding BATTERY REPLACEMENT in this manual.

Gauge Mode Alarm

You will hear your dive computer sound its five-chirp alarm just prior to entering the Gauge Mode. It will re-issue its five-chirp alarm if the TU is powered up within 24 hours after entering Gauge Mode.

Your computer will enter the Gauge Mode if:

- more than five minutes has elapsed with the depth less than the ceiling
- or
- a ceiling depth of 90 feet or greater is required
- or
- the maximum functional operating depth of 327 feet is exceeded.

Two-Minute Warning

Should you have less than two minutes of remaining no-decompression time, your dive computer will:

- issue a one time, five-chirp audible warning
- and
- flash the WARNING legend on the WU.

60 Foot Decompression Stop Warning

Should you require a decompression stop greater than 60 feet, the unit will issue a one time five-chirp audible warning.

Entering Emergency Decompression Mode

Should you enter Emergency Decompression Mode, the TU will issue a one time five-chirp audible alarm.

Oxygen Tolerance Units (OTU) Dose Warning

Should you reach 75 percent of the allowable Mission OTU dosage, your dive computer will issue a one-time audible warning consisting of short, double-beeps that sound for five seconds. The WARNING legend will appear and flash and the TEMPerature digits will be replaced with the current calculated OTU toxicity percentage. This visual warning will continue until the calculated toxicity percentage is less than 75 percent.

Central Nervous System (CNS) Oxygen Toxicity Warning

Should you reach 75 percent of the associated maximum limit, your dive computer will issue a one-time audible warning consisting of short, double-beeps that sound for five seconds. The **WARNING** legend will appear and flash and the **TEMP** digits will be replaced with the current calculated CNS Oxygen Toxicity percentage. This visual warning will continue until the calculated toxicity percentage is less than 75 percent. (FIG-15 shows a diver that has reached 92% of the allowable maximum bottom time for any PO_2).

NOTE: If both **CNS** and **OTU** levels are greater than 75 percent, the more critical of the two's percentage will be displayed.

NOTE: By accepted definition of **CNS Toxicity**. Should a PO_2 value greater than 1.6 ATA be measured, the **CNS Toxicity** will be 100%.

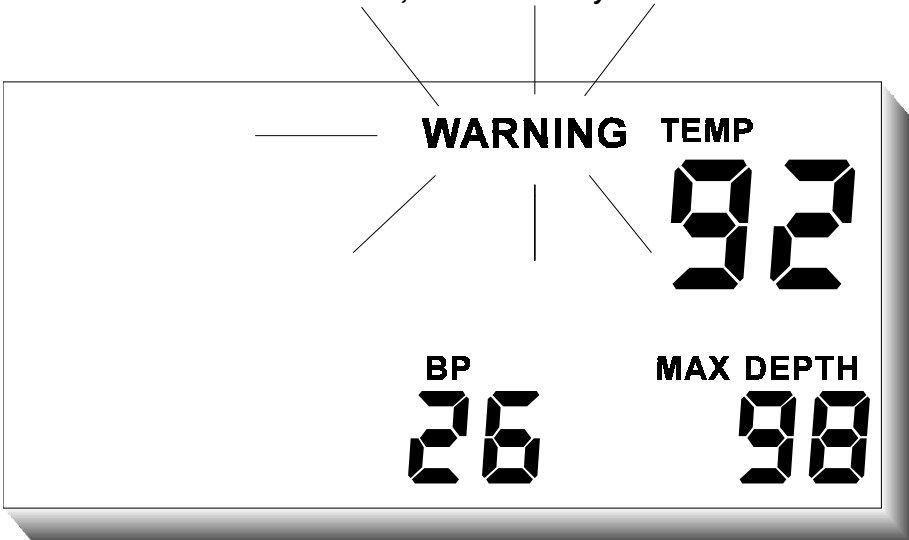

FIG-15
OXYGEN TOXICITY WARNING DISPLAY

Maximum PO_2 Alarm:

This alarm, settable via the optional **Analyst[®]** interface, allow you to set a desired maximum PO_2 level from 0.5 to 1.6 ATA. Should you exceed this setting, the TU will issue the double chirp toxicity alarm once per minute. The factory setting for this alarm is 1.6 ATA.

DATA STORAGE TYPES & CAPACITY: The NEMESIS[®]+ has the following internal distinct data storage activities that can be recalled, viewed, and stored with the ANALYST[®] PC computer interface:

- **Current Variable Information:** Local Time, *CNS toxicity*, *OTU dose*, *OTU Mission Clock*, Altitude, Battery voltage, 12 tissues loading.
- **Current Configuration Data:** As can be seen in “USER CONFIGURABLE ITEMS”, below.
- **Historical Totals Summaries:** Dive Time, Number of Dives, Number of Marginal Dives, Number of Violated Dives, Number of Warnings, Decompression Dives, and Decompression Time.
- **Each Dive Beginning Statistics:** 12 tissues loading, Local Time Clock, Dive of Day, Dive Number, Surface Time, Beginning Tank Pressure, Beginning Breathing Parameter, *CNS Toxicity*, *OTU Dose*, *Mission Clock*, Altitude, Time to Fly, Battery Voltage, Altitude. Capacity is the most recent 100 dives.
- **Each Dive Ending Statistics:** 12 tissues loading, Bottom Time, Ending Tank Pressure, Ending Breathing Parameter, Average Breathing Parameter, Max Breathing Parameter, Max Depth, Average Depth, Min NDC Time, Min Air Time, Max Deco Time, Max Deco Ceiling, Missed Ceiling, Missed Deco Time, *CNS Toxicity*, *OTU Dose*, *Max PO₂*, Max Ascent Rate, Max A/R Time, Max A/R Depth, Min Temperature, Average Temperature, Maximum Temperature, Min Battery Voltage, Time to Fly, Tank Size, and the number of Warnings. Capacity is the most recent 100 dives.
- **Each Dive Configuration Data:** Full and complete configuration of the system, including Oxygen %, and User Conservatism. Capacity is the most recent 100 dives.
- **Profile Graphical Information:** Depth Graph, Tank Pressure Graph, Breathing Parameter Graph, Ascent Rate Graph, Temperature Graph, *PO₂ Graph*, *CNS Graph*, and *OTU Graph*. Capacity is 13 hours at one second sampling, 26 hours at two second sampling, etc.
- The user via the ANALYST[®] can set sampling from one to 15 seconds sampling. Uploading to a PC often via the ANALYST[®] prevents earlier data overwritten by more recent data from being lost forever. Default from the factory is four-second sampling. The sampling rate does not affect the compute rate, which remains fixed at one second.

USER CONFIGURABLE ITEMS: By using the optional ANALYST[®] Personal Computer Interface, the user has the ability to change the following items:

Dive Time/date Stamp: This is the internal clock setting that is used by the system to time-stamp each individual dive as it occurs. Due to changes in battery voltage and temperature, the internal Time-of-day clock may slowly drift from the ideal. It is recommended that this clock be periodically set to your local time via the ANALYST[®].

PreDive Planning Maximum Depth: This option allows you to enter the maximum depth that will be predicted during the PreDive Prediction Mode. You may enter this maximum depth in 10-foot increments from 0 to 320 feet. If zero is selected, there will be no PreDive Planning.

Select Altitude <2000 feet as One Zone (Off or On): This option provides "actual" altitude for any given day at any diving location as explained in the previous section "ALTITUDE ACCLIMATIZATION". With changes in barometric pressure due to temperature and weather systems, it is possible, even expected, to have a different apparent altitude at the same dive site from day to day.

While the seamless means of monitoring provides the most accurate decompression schedule, all altitudes less than 2,000 feet above sea level can be treated in the algorithm as sea level if so selected.

With this option OFF, the unit is calculating altitude in a seamless fashion. With this option ON altitudes less than 2,000 feet above sea level will be treated as sea level. Regardless of the selection, altitudes greater than 2,000 feet above sea level will be treated in a seamless manner. From the factory, this is set to sense seamless altitude from sea level to 15,000 feet above sea level.

Select Decompression Time Display (Total, Stop, Both): There are three options for the manner in which the decompression time is displayed. If you select TOTAL, the decompression time displayed will indicate the total time you will spend in decompression, including ascent to the surface.

Watch the Ceiling depth change in order to identify when to ascend to the next stop depth. If you select STOP, the decompression time displayed will indicate the time you must remain at the current Ceiling. When this time is 0:00, the Ceiling depth will decrease and the new stop time will be displayed. If you select BOTH, the TOTAL time and STOP time will alternate at the rate of once every 2 seconds. From the factory, the unit is set to BOTH.

Temperature Dependent NDC Computations (Off or On): This feature compensates the decompression algorithm proportional to the ambient water temperature if the water temperature is below 75 degrees F. If the diver is using a warm, well-insulated dry suit, it may be desirable to turn this feature off.

See previous explanation of this capability. The NEMESIS®+ is shipped from the factory with this feature ON.

Workload Dependent NDC Computations (Off or On): This feature compensates the decompression algorithm proportional to Divers workload. The NEMESIS®+ is shipped from the factory with this feature Off.

Selectable NDC Conservatism (0% to 50%): This feature will allow the diver to input an added degree of conservatism to the decompression algorithm from 0 to 50 percent in one-percent increments. This may be desirable if the diver is dehydrated, tired, or has some other factor that warrants added conservatism. This option may also be set via the Field Programming method. Conservatism is set to zero as shipped from the factory.

Select Cylinder Size: This is the TOTAL volume (in liters) of all the connected diving cylinders. If you were diving twin ten-liter tanks, you would enter 20 (for more information on calculating cylinder size refer to page 57).

Select Field Programming Option: This option enables and disables the ability to use your computer with the Field Programmer.

Selectable Type of Ascent Rate Alarm (Fixed or Variable): This option gives the diver the ability to utilize a fixed ascent rate warning or a warning based on depth. Should the diver prefer the fixed ascent rate warning, the diver can select the maximum ascent rate limit, which can be selected in one-foot increments from 20 to 60 feet per minute (See next topic). As shipped from the factory, this is set to FIXED. If the VARIABLE rate is selected then the warning will illuminate based on the following table:

<u>DEPTH</u>	<u>AVERAGE ASCENT RATE</u>
60 feet and deeper	60 feet per minute
59 to 30 feet	same as depth
Shallower than 30 feet	30 feet per minute

The NEMESIS[®]+ is shipped from the factory as FIXED with a 60 feet-per-minute alarm.

Selectable Fixed Ascent Rate Alarm Limit: If FIXED Ascent Rate alarm was selected from the above topic, the user may enter the desired Ascent Rate for the alarm to sound. As shipped from the factory, this is set to 60 feet per minute. The NEMESIS[®]+ is shipped from the factory as FIXED with a 60 feet-per-minute alarm.

Selectable Ascent Rate Bar Graph (Fixed or Proportional): This option determines whether the Ascent Rate bar graph indicates the speed of ascent or the percentage of the selected maximum ascent rate. The NEMESIS[®]+ is shipped from the factory as FIXED.

Selectable Logbook Dwell Time (10 to 60 seconds): This feature allows the diver to determine how long (in seconds) that a particular dive's logbook is displayed before the Logbook Mode is exited. This option is set to 30 seconds as shipped from the factory.

Ascent Rate Responsiveness (0 to 7): This option determines the responsiveness or sensitivity of the Ascent Rate Bar Graph. Zero is highly responsive and seven is very slow. This feature is set to three as shipped from the factory.

Remaining Time Responsiveness (0 to 7): This determines the responsiveness of the Remaining Time information that is displayed. Zero is highly responsive and seven is very slow. This feature is set to three as shipped from the factory

Breathing Parameter Responsiveness (0-7): This determines the responsiveness of the Breathing Parameter information that is displayed. Zero is highly responsive and seven is very slow. This feature is set to three as shipped from the factory

Metric or Imperial: The diver may select whether the data is computed and displayed in Metric or Imperial units. The NEMESIS[®]+ may be ordered either way as shipped from the factory.

Max Depth Alarm: This option allows the diver to select a maximum depth, below which, the diver does not wish to descend before an alarm is sounded. This function is disabled when in the Decompression Mode. The Field Programming Mode previously described may also modify this setting. As shipped from the factory, the Depth Alarm is set for 130 feet.

Select Nitrox Computations (Off or On): *This option enables and disables NITROX computations. If this option is disabled, mixtures other than 21.0% oxygen will be disallowed. Furthermore, if this option is selected as OFF, the NEMESIS®+ will not compute CNS Toxicity, OTU Dose, or maximum PO₂ alarm. The factory setting for this option is ON.*

Enter Oxygen % in Nitrox Mixture: *This option allows you to enter the tested oxygen percentage in 0.1% increments. Values from 21.0% to 50.0% may be entered. The Field Programming Mode previously described may also modify this setting. As shipped from the factory, this is set to 21.0% or air.*

Max PO₂ Alarm: *This option allows the diver to select a maximum PO₂ (Partial Pressure of Oxygen) at which an alarm is sounded. Values from 0.50 to 1.60 are allowed. This is set to a PO₂ of 1.6 at the factory before shipping.*

Profile Storage Period (1 to 15 Seconds): This option allows the diver to select the sample rate at which data is stored for later recall by the ANALYST®. This option does not affect how frequently the computer performs its calculations, but only how often data of the dive in progress is stored for later retrieval. The faster (lower the number) the profile storage period, the more precise the re-creation of the dive will be.

However, this will also limit the number of dives retained in memory for later recall. For optimum re-creation of dives, sampling periods of greater than four seconds are not recommended. For each one-second increase in the sampling rate, the NEMESIS®+ will store an additional 13-hours of profiles. As shipped from the factory, Profile Storage period is set to four seconds which allows for 52 hours of storage before the earlier profiles are overwritten.

CAUTION: If the computer is not uploaded to a PC via the ANALYST® before this period expires, some dive profiles will be irretrievably lost.

QUESTIONS AND ANSWERS

- Q.** Should I turn my WU off when it is not in use?
- A.** Yes. While your WU is powered by two alkaline 'N' batteries that will provide a long battery life, you still should turn the WU off when you are going to be away from the TU for an extended time (see Page 14).
- Q.** Shouldn't I take the batteries out of the TU when my dive computer is not going to be used for several months?
- A.** **No.** Inside your TU is a small lithium battery that provides power for long-term data storage. Removing the batteries, or leaving fully discharged batteries in the TU, will cause this coin cell to gradually lose its power. Also, the timestamp clock does not operate when the batteries are removed.
- A.** Is this coin cell replaceable?
- Q.** The coin cell can only be replaced by Cochran Undersea Technology since it requires the opening of the TU. By keeping charged batteries in the TU, the battery life of this coin cell is expected to be over ten years.
- Q.** When I change the batteries in my TU, will my dive computer retain data for the current dive?
- A.** Yes, providing you follow the instructions on battery replacement.
- Q.** When I tapped the TU on, it did not issue the five confirmation beeps, WHY?
- A.** The TU may already be on. Turn your WU on to see if the TU is transmitting data. If it is not, check the batteries to see if their voltage is low. In a noisy environment, such as on the boat when it is underway, it may be difficult to hear the confirmation beeps.
- Q.** At what battery voltage will my TU cease to operate?
- A.** Fully charged, the four AA alkaline batteries provide 6.0 volts. When they discharge to below 4.8 volts, your TU will not turn on.
- Q.** Can I turn the TU on underwater?
- A.** No. The TU will not turn on if you are underwater. Should you enter the water and begin a descent without turning the TU on, slowly surface, turn the TU on, wait for it to complete its Self-Diagnostic Mode, and then begin your descent once again.
- Q.** Is the transmitting range affected by the positioning of the TU and WU?
- A.** Yes, however, in normal diving situations there is sufficient operating range regardless of orientation.

- Q.** What is the proper way to tighten the TU and WU battery caps?
- A.** The caps should be tightened using the enclosed battery removal tool. The o-rings should not be visible when the caps are properly tightened, but be careful not to overtighten the caps. Once the o-rings are seated, simply hand-snug each cap.
- Q.** What happens if the battery compartments flood?
- A.** The electronics of both the TU and WU are completely environmentally sealed. The construction of the battery compartments will not allow water to enter the electronics. If you have flooded the battery compartments, first rinse the compartments as soon as possible with fresh water. Then fill each compartment with alcohol and shake the alcohol to ensure complete rinsing. Drain the alcohol and allow the compartment to air-dry 12 hours with the battery caps off. Discard the batteries. Finally, examine the battery cap, replace and lubricate the o-rings, install new batteries and reinstall the battery caps. You may also need to use a clean eraser or a burnishing cloth to completely clean the contacts.
- Q.** Can I transport my dive computer in a watertight container while traveling at altitude?
- A.** No. Your dive computer continuously monitors the altitude to perform nitrogen in-gassing and out-gassing. These nitrogen levels are then used when you arrive at the dive site and intelligently applied to your dive.
- Q.** What should I do if I have additional questions?
- A.** Call us! For your convenience, we are available Monday through Friday, 8:00 a.m. to 5:00 p.m. Central Time. Our staff of certified instructors will be glad to assist you by answering any of your questions. Our telephone number is 972.644.6284. You may also FAX questions to 972.644.6286 or E-MAIL your questions to service@divecochran.com.

Most problems can be resolved without returning the unit. The unit may also be returned to the place of purchase and request the dealer to contact us. If this is not possible or is inconvenient due to change in location, contact us for the name of the nearest Team Cochran Authorized Dealer.

SECTION IV CARE AND MAINTENANCE

Rinsing and Cleaning:

Your dive computer is designed to require minimum care and maintenance. Both the TU and WU are molded from fiberglass-reinforced resins that are extremely resistant to salt, chlorine, and exposure to ultraviolet light. However, both the TU and WU contain sophisticated electronic components, and therefore, require reasonable care and treatment.

- Avoid sharp impacts to the TU and WU.
- Do not expose units to extreme heat or cold.
- Replace batteries when they become discharged, or once a year, whichever should occur first.
- Rinse both units with fresh water and allow them to air-dry after each use. Take special care when rinsing the opening on the TU that is between the battery caps. **DO NOT** attempt to clean this area with a pointed object or with blasts of compressed air. Doing so will cause severe damage to your TU, rendering it inoperable and voiding the Warranty

You can extend the service life of your dive computer by simply rinsing it with fresh water. When using a garden hose to rinse your unit, keep the water pressure very low. No chemicals of any type should be used on your dive computer. The WU's rubber strap may be conditioned with silicone spray especially developed for use with SCUBA equipment. You will find this type of silicone spray at your local dive shop. Care should also be taken to prevent your WU's lens from becoming scratched or damaged. Minor scratches will become invisible underwater. However severe gouges or cracks in the lens would require that it be replaced.

High-pressure Transducer Care:

When installing your high-pressure transducer, use the supplied wrench, scuba tool or a thin open-ended wrench on the transducer's hex nut to tighten, **DO NOT use tools such as vise-grips or channel lock pliers. These tools can damage the transducer and such damage is not covered by the limited warranty.** When the TU is not attached to your regulator, replace the dust cap on the high-pressure transducer to prevent contaminants from entering the opening. **NEVER** insert any object into the high-pressure transducer opening. **SEVERE DAMAGE** may result.

Battery Type and Replacement:

Your dive computer operates on two different sizes of user-replaceable batteries. The TU requires four alkaline 'AA' batteries while the WU requires 2 alkaline 'N' batteries. We recommend using only high quality non-tester alkaline batteries for both the TU and the WU. **Other types of batteries (such as Lithium and Nickel Cadmium) may permanently damage the Tank Unit or Wrist Unit and void the warranty.** Use of old, off-brand, incorrect and/or visibly corroded batteries will also affect performance, damage the units, and void the warranty.

There are factors, which can significantly vary battery-operating life. These include:

- Original quality of battery as manufactured.
- Age of battery prior to installation.
- Length of time the batteries have been installed.
- Frequency and cumulative number of WARNINGS issued by the computer.
- Temperature of battery in operation.

Fresh batteries installed in the TU will read about 6 volts. At 5.4 volts the low battery indicator is shown on the WU. At 4.8 volts, your TU will not turn on. Since the WU is equipped with the TACLITE backlit display, battery life in the WU will be affected depending upon the number of times you activate the TACLITE. On a new, fresh set of N-type batteries in the Wrist Unit, you should get approximately 10,000 TACLITE cycles.

To replace batteries:

- a) Prepare four new AA alkaline batteries (NO Lithium)
- b) Double check the orientation of batteries with the picture on the bottom of the battery tubes
- c) Remove one battery cap; replace batteries, re-install the battery cap carefully making sure not to cross-thread the battery cap
- d) **Wait one minute**
- e) Remove other battery cap; replace batteries, re-install the battery cap carefully making sure not to cross-thread the battery cap

NOTE: The one minute delay allows the power circuit responsible for maintaining power to the TU during a battery change, time to recharge.

Battery Care:

Two separate, sealed TU battery compartments isolate the alkaline batteries from the Primary computer. Gases given off by the chemical reaction that produces electricity within batteries react with the metal contacts of the batteries, causing corrosion. Over time, this coating accumulates and lowers the amount of power the battery can deliver. Even though batteries that have been in the dive computer for a period of time may indicate ample voltage, the corrosion interferes with delivery of power from the battery to the dive computer. Preventive maintenance in the form of the periodic burnishing of the battery's contacts and applying a thin film of silicone grease to the battery terminals will greatly minimize this corrosion from forming.

NOTE: It is always advisable to replace older or questionable TU batteries with new, fresh batteries before a long series of dives, especially if your dive computer has been inactive for an extended time.

NOTE: Remember, your TU cannot be manually turned off; and since the TU computes all of the diving data, turning your WU off will not affect your decompression information. Residual nitrogen elimination, as well as time-to-FLY can be viewed by turning the WU back on.

DO NOT ALLOW THE NEMESIS®+ TO HAVE LOW OR NO BATTERIES FOR ANY EXTENDED PERIOD OF TIME! THIS WILL DISCHARGE THE INTERNAL LITHIUM BATTERY THAT KEEPS THE MEMORY ALIVE!

CAUTION!!! LOSS OF BATTERY POWER WILL CAUSE ALL PREVIOUS DIVE NITROGEN LOADING TO BE LOST. THIS MAY AFFECT NITROGEN CALCULATIONS ON NEAR-FUTURE DIVES. AFTER A BATTERY CHANGE, CONFIRM THAT NO-DECOMPRESSION TIME DATA IS REASONABLE DURING PRE-DIVE PREDICTION MODE. DIVE-OF-DAY NUMBER GOING TO ZERO IMMEDIATELY AFTER CHANGING BATTERIES IS ANOTHER INDICATION OF A LOSS OF NITROGEN LOADING.

- **NEVER TEST OR SUBJECT THE PRODUCT TO PRESSURIZED AIR!**
- **NEVER REMOVE THE LENS FROM THE UNIT!**
- **ONLY USE FRESH WATER TO CLEAN THE UNIT! NEVER USE SOLVENTS!**
- **DO NOT USE A SCREWDRIVER TO REMOVE THE BATTERY CAPS!**
- **ALWAYS KEEP FRESH BATTERIES INSTALLED!**
- **ALWAYS USE 1.5 VOLT ALKALINE BATTERIES!**
- **LUBRICATE BATTERY ENDS WITH A THIN FILM OF SILICONE GREASE!**

SECTION V

TECHNICAL SPECIFICATIONS

(Subject to change without notice)

No-Decompression Model

Algorithm: Modified Haldanean
 Number of Half Time Compartments: 12

Decompression Ceilings

Ceiling Depths: 10, 20, 30, 40, 50, 60, 70, 80, 90 feet
 3, 6, 9, 12, 15, 18, 21, 23, 27 meters

Altitude Diving Model

Procedure: Altitude adjust is seamless from sea level to 15,000 feet (4600 meters) above sea level.

FUNCTIONAL

	RANGE	INCREMENT
Dive Number	0 - 9 dives	1 Dive
Depth	0 - 327 feet	1 Foot
	0 - 99.9 meters	0.1 meter
Temperature	0 - 99 deg F.	1 degree
	0 - 37 deg C	1 degree
Surface Time	0 - 17 hours 03 minutes	1 minute
Maximum Depth	0 - 327 feet	1 foot
	0 - 99.9 meters	0.1 meter
Tank Pressure	0 - 5119 psi	1 psi
	0 - 353 BAR	0.1 BAR
	0 - 360 Kg/cm ²	0.1 Kg/cm ²

OPERATIONAL

Depth/Max Depth 327 feet / 99.9 meters

Depth Gauge Range	327 feet / 99.9 meters
Tank Pressure	5119 psi 353 BAR 360 Kg/cm ²
Clock Timer	17 hours 03 minutes
Logbook	300 dives
Dive Of The Day Counter	9 dives
Altitude	15,000 feet / 4,600 meters
Altitude Functional Range	15,000 feet / 4,600 meters
Breathing Parameter	98 psi per minute
Second-by-second Profiles	13.6 hours

HARDWARE

Casing	Fiberglass reinforced ABS Plastic
Lens Material	Polycarbonate

POWER

	TANK UNIT	WRIST UNIT
Battery	4 'AA'	2 'N'
Battery type	Alkaline	Alkaline

TURN-ON

	TU	WU
Activation	Sonic/Tank Pressure	Inertial Switch

ACCURACY

Temperature	+/- 1.5% full scale
Depth Gauge	+/- 1.0% full scale
Tank Pressure	+/- 1.0% full scale
Bottom/Surface Time	+/- 1.0 sec. /24 hours

REPLACEMENT PARTS

High-pressure O-ring:	90D	VITON
Tank Unit Battery Cap O-ring:	-207 BUNA N	SILICON
Wrist Unit Battery Cap O-ring:	-038 BUNA N	SILICON

SECTION V

ACCESSORIES

Field Programmer LIMITED 90-DAY WARRANTY

To the original owner only, Cochran Undersea Technology, a division of Cochran Consulting, Inc. guarantees the Field Programmer to be free of defects in both materials and craftsmanship under normal SCUBA use for 90 days from the date of purchase. Failing to provide proper care will cause this warranty to be null and void. Any defect not excluded in the limitations section below will be repaired, replaced, or replaced with a refurbished unit, at Cochran Undersea Technology's discretion, free of charge. This warranty does not include charges for shipping and handling. This warranty IS NOT transferable. A photocopy of the original sales receipt MUST accompany all correspondence concerning this warranty.

Should repair be required you may return your Field Programmer to the place of purchase.

LIMITATIONS

This warranty DOES NOT cover any damages that occur from abuse, tampering, or accident. Additionally, any modifications or repairs performed by anyone other than an authorized Cochran Undersea Technology Repair Center to this unit will void this warranty. All plastics, rubber or damage due to accident, abuse, modification, or tampering are NOT covered.

STATEMENT OF LIABILITY

It is expressly understood that by buying and/or using the Field Programmer, the diver assumes ALL risk as to its quality, performance, and accuracy. Cochran Undersea Technology, its distributors, or retailers will not be held liable for any personal injuries or other damages resulting from its operation, even if Cochran Undersea Technology has been advised of such occurrences and damages.

OVERVIEW

The Field Programmer is designed for use with the NEMESIS®+ Dive Computer. IT IS NOT COMPATIBLE WITH PREVIOUS NEMESIS or NEMESIS II DIVE COMPUTERS. This device allows the user to program into the dive computer a *value representing the percentage of oxygen contained in a given breathing gas mix*, the cylinder size which is used in making Workload computations, an added degree of conservatism from 0 to 50%, and a maximum depth alarm.

WARNING: The NEMESIS®+ Dive Computer and the Field Programmer are to be used only by divers trained and certified in the use of Nitrox breathing gas mixes by an accredited certifying agency.

NOTE: The Field Programmer is NOT waterproof.

Installation

To install, orient the probe of the Field Programmer so that the wire running to the pushbutton box is running in the same direction as the high-pressure transducer. See Fig. 16.

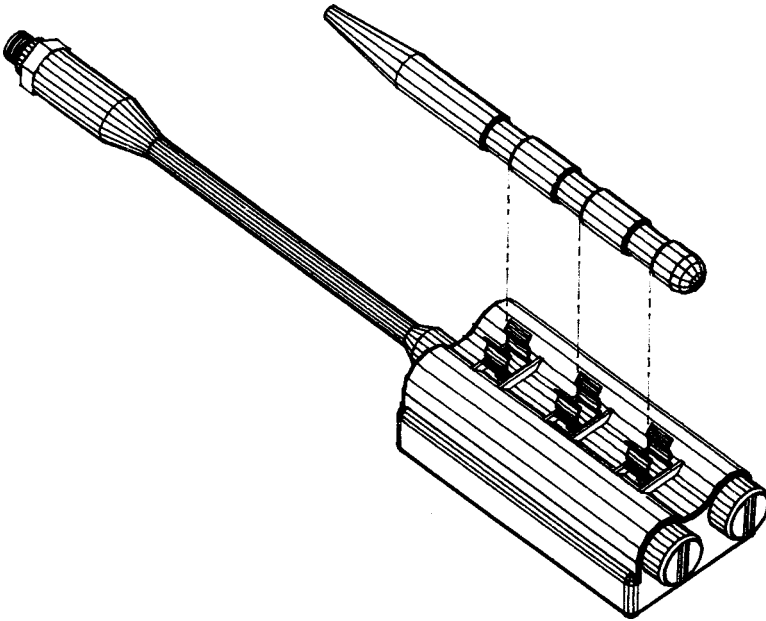

Fig. 16

Field Programming Mode – With Nitrox Disabled

1. Turn the TU on manually.

NOTE: The sound generated by installing the probe may activate the TU. If this is the case, it is not necessary to perform this step.

2. Turn the WU on and position it to receive the transmissions from the TU.

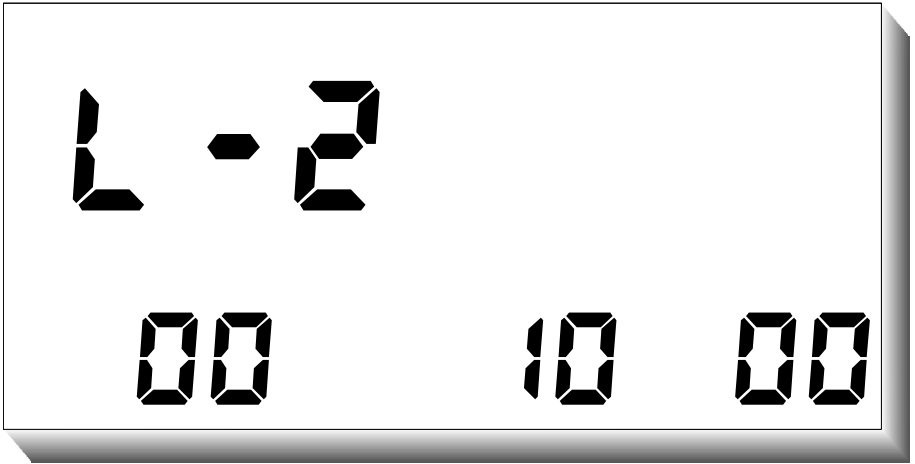

**Fig-18
Field Programming
(Setting Cylinder Size)**

3. While the NEMESIS®+ is in the normal Surface Mode, tap the TU on the PWR circle one time. You should see the WU display change to the programming display.
4. The first display seen is for programming the Cylinder Size in liters. The upper left-hand corner will display a “L-2”. The “L” indicates that you are programming Cylinder Size and the “-2” indicates that the 10’s digit is being programmed. The Cylinder Size being programmed is displayed bottom center. Upon initial programming, this value should display 11 as set from the factory. Whole liters up to 255 are allowed. The formula to calculate liters is:

Cylinder Size (cu.ft.) divided by Working Pressure (psi) multiplied by 411 = Liters

For example, an 80 cu.ft. cylinder rated at 3000 psi would be calculated as follows:

$$\frac{80}{3000} \times 411 = \text{Liters} \qquad 0.0266666 \times 411 = 10.959972 \text{ Liters}$$

This would be rounded to 11 Liters.

5. Using the INCREMENT button (the one closer to the data probe wire), program the 10’s digit. Each push of this button will increment the digit by one. A confirmation chirp will be heard with each increment in value and the upper left corner of the WU display will read “L-2”.

6. Once you have programmed the 10's digit, press the SELECT button (the one farthest from the data probe wire) to move to the 1's digit. The WU will now display "L-1". Using the INCREMENT button, program the 1's digit to the desired setting.

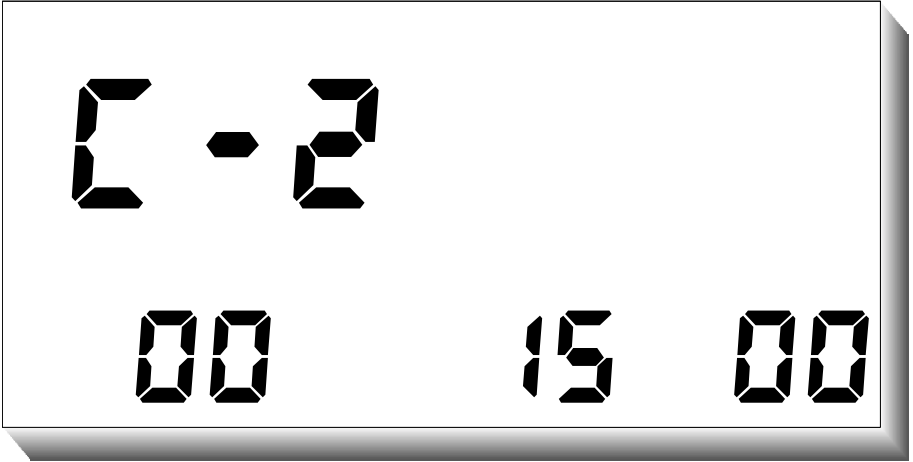

Fig-19
Field Programming
(Setting Conservatism)

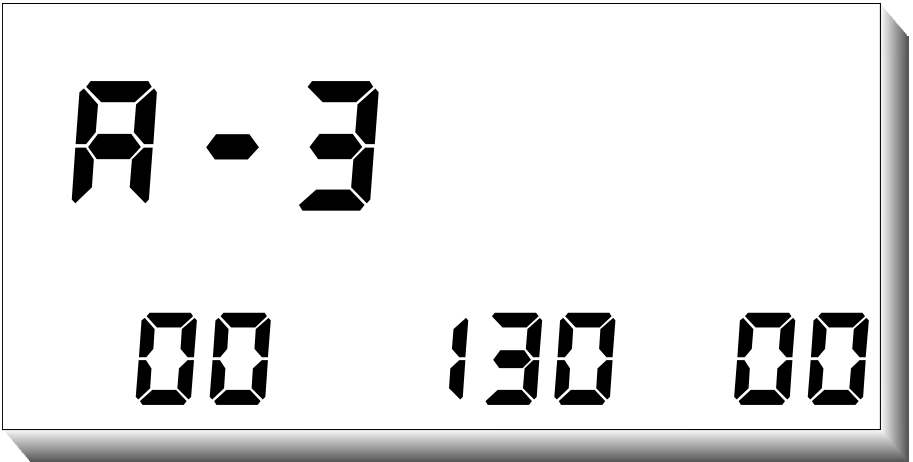

Fig-20
Field Programming
(Setting Depth Alarm)

All programming sequences use the same routine of using the SELECT button to select the next programming sequence and the INCREMENT button to increment the specific value. If a value requires three digits to be programmed a -3, then a -2 and then a -1 will be displayed in the upper left-hand corner. The -3 identifies the most significant digit, or the far left digit, of the value being displayed. The -2 identifies the next most significant digit, or the center digit, of the value being displayed. The -1 is the least significant digit, or the right digit, of the value being displayed.

For Depth Alarm, the -3 identifies the 100's digit, the -2 identifies the 10's digit and the -1 identifies the 1's digit. Some values only have two digits. For these values, only a -2 and a -1 will be displayed.

Once all of the desired values have been programmed, you must SELECT through the entire programming sequence WITHOUT making any additional changes before the NEMESIS®+ will exit the Programming Mode with all the values saved into memory. It is strongly recommended that the Programming Mode is activated again and a complete review of what was stored is accomplished.

NOTE: If you wish to leave a particular digit unchanged, press the SELECT button to move to the next programming step.

Field Programming Mode – With Nitrox Enabled

1. *Analyze the gas blend using a calibrated Oxygen Analyzer*
2. *Turn the TU on manually.*

NOTE: The sound generated by installing the probe may activate the TU. If this is the case, it is not necessary to perform this step.

3. *Turn the WU on and position it to receive the transmissions from the TU.*
4. *While the NEMESIS®+ is in the normal Surface Mode, tap the TU on the PWR circle one time. You should see the WU display change to the programming display.*
5. *The first display seen is for setting the oxygen percentage. The upper left corner will display a "1-3". The "1" indicates you are programming the oxygen percentage and the "-3" indicates the 10's digit is being programmed. The Oxygen Percentage being programmed is displayed bottom center. Upon initial programming, this value should display 21.0 as set at the factory. At the bottom left, the current CNS Oxygen Toxicity percentage is displayed while the current OTU percentage is displayed in the lower right.*



Fig-17
Field Programming
(Setting Oxygen %)

- Using the INCREMENT button (the one closest to the data probe wire), program the 10's digit. Each push of the button will increment the digit by one. A confirmation beep will sound with each increment. If a diving mix of 40.0%. The INCREMENT button should be pushed until a '4' is displayed at the bottom center's 10's digit.

NOTE: The maximum 10's digit accepted by the TU for the O2 percentage for the Mix is 5 since the maximum percentage of oxygen allowed is 50.0 percent. The Field Programmer will increment this digit up to 9 since the DEPTH ALARM can be programmed for 290, 190 or 90.

- Using the SELECT button, you now move to the 1's digit. A '1-2' will be displayed in the upper left-hand corner of the display. The "1" identifies that the oxygen percentage is still being programmed and the "-2" identifies the 1's digit is being programmed.
- Program this value as in step six. If the example of setting the oxygen percentage of 40.0% were continued, the INCREMENT button would be pushed until "0" appears in the 1's digit at the bottom center of the display.
- Using the SELECT button, you now move to the 1/10's digit. A '1-1' will be displayed in the upper left-hand corner of the display. The "1" identifies that the oxygen percentage is still being programmed and the "-1" identifies the 1/10's digit is being programmed.
- Program this value as in step six. If the example of setting the oxygen percentage of 40.0% were continued, the INCREMENT button would be pushed until "0" appears in the 1/10's digit at the bottom center of the display.

11. Use the **SELECT** button move to the next selection.

All programming sequences use the same routine of using the **SELECT** button the select the next programming sequence and the **INCREMENT** button to increment the specific value. If a value requires three digits to be programmed a -3, then a -2 and then a -1 will be displayed in the upper left-hand corner. The -3 identifies the most significant digit, or the far left digit, of the value being displayed. The -2 identifies next most significant digit, or the center digit, of the value being displayed. The -1 is the least significant digit, or the right digit, of the value being displayed.

For Oxygen Percentage, the -3 identifies the 10's digit, the -2 identifies the 1's digit and -1 identifies the 1/10's digit. For Depth Alarm, the -3 identifies the 100's digit, the -2 identifies the 10's digit and the -1 identifies the 1's digit. Some values only have two digits. For these values, only a -2 and a -1 will be displayed.

Once all of the desired values have been programmed, you must SELECT through the entire programming sequence WITHOUT making any additional changes before the NEMESIS®+ will exit the Programming Mode with all the values saved into memory. It is strongly recommended that the Programming Mode is activated again and a complete review of what was stored is accomplished.

NOTE: If you wish to leave a particular digit unchanged, press the SELECT button to move to the next programming step.

The table below lists the various programming sequence and their display identifications.

Identification	Description
1-3 1-2 1-1	<i>Oxygen %, Maximum allowable value is 50%.</i>
L-2 L-1	Cylinder size in liters, Maximum allowable value is 255.
C-2 C-1	Added Conservatism, Maximum allowable value is 50%.
A-3 A-2 A-1	Depth Alarm, Maximum Allowable value is 327 feet.

ANALYST® PERSONAL COMPUTER INTERFACE

The Analyst® Personal Computer Interface Is a complete hardware/software systems that uploads data from the NEMESIS®+ dive computer to an IBM or compatible Personal Computer with a Windows® 95/98/NT operating system. The Analyst® Personal Computer Interface allows the diver to retrieve dive data, customize the dive computer and to also enter and store additional information for each dive in a logbook database. Visit Your Team Cochran Dealer for a demonstration.